

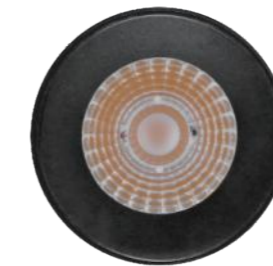

TL 10 Series
Surface Mounted Spotlight



- Top brand high lumen COB LED, luminous efficiency of the whole lighting fixture can be above 85lm/w.
- Horizontal rotation 350° and vertical tilt 90°, achieving precise spotting angle.
- Anti-glare designed lamp body.
- Use high quality die-casting aluminium heat sink with convection cooling method, cooling fast to low down luminous decay efficiently.
- Same light with track, recessed, and mounted installation method.



KAS-TL10L-D-50
Power: 7W
Diameter: 50mm

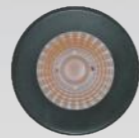
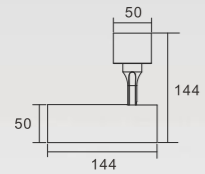

KAS-TL10L-D-66
Power: 10W/15W
Diameter: 66mm

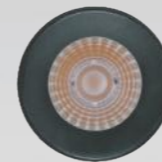
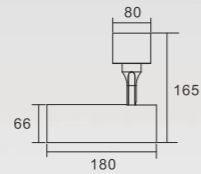

KAS-TL10L-D-80
Power: 25W/30W
Diameter: 80mm

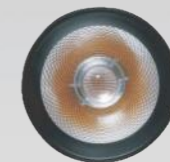
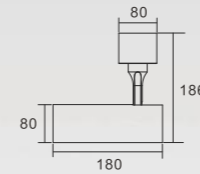

KAS-TL10R-D-80
Power: 25W/30W
Diameter: 80mm

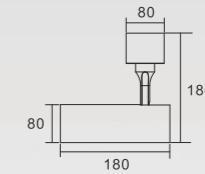



KAS-TL10L-D-50
Power: 7W
Diameter: 50mm

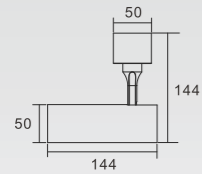

KAS-TL10L-D-66
Power: 10W/15W
Diameter: 66mm

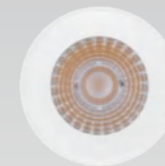
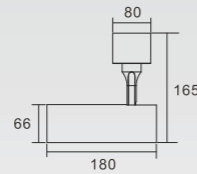

KAS-TL10L-D-80
Power: 25W/30W
Diameter: 80mm

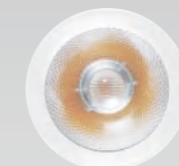
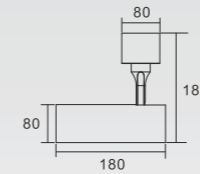

KAS-TL10R-D-80
Power: 25W/30W
Diameter: 80mm

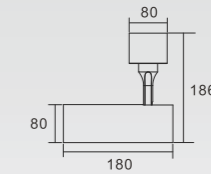

TL 10 Series
Surface Mounted Spotlight

Model	KAS-TL10L-D-50	KAS-TL10L-D-66	KAS-TL10L-D-80	KAS-TL10R-D-80		KAS-TL10L-D-50	KAS-TL10L-D-66	KAS-TL10L-D-80	KAS-TL10R-D-80
Product Photo									
Dimension(mm)									
Wattage	7W	10W/15W	25W/30W	25W/30W		7W	10W/15W	25W/30W	25W/30W
CCT	3000K/3500K/4000K	3000K/3500K/4000K	3000K/3500K/4000K	3000K/3500K/4000K		3000K/3500K/4000K	3000K/3500K/4000K	3000K/3500K/4000K	3000K/3500K/4000K
CRI	>90	>90	>90	>90		>90	>90	>90	>90
Beam Angle	10°/15°/20°/30°	10°/15°/20°/36°	10°/15°/20°/36°	20°/24°/30°/36°		10°/15°/20°/30°	10°/15°/20°/36°	10°/15°/20°/36°	20°/24°/30°/36°
Lumen	385LM	800-1125LM	2125-2400LM	2000-2250LM		385LM	800-1125LM	2125-2400LM	2000-2250LM
IP	IP 20	IP 20	IP 20	IP 20		IP 20	IP 20	IP 20	IP 20
Dimming		TRIAC/1-10V	TRIAC/1-10V/DALI	TRIAC/1-10V/DALI			TRIAC/1-10V	TRIAC/1-10V/DALI	TRIAC/1-10V/DALI
Accessory	Honeycomb Filter Stripped Glass Fabric Glass	Honeycomb Filter Stripped Glass Fabric Glass	Honeycomb Filter Stripped Glass Fabric Glass	Honeycomb Filter Stripped Glass Fabric Glass		Honeycomb Filter Stripped Glass Fabric Glass	Honeycomb Filter Stripped Glass Fabric Glass	Honeycomb Filter Stripped Glass Fabric Glass	Honeycomb Filter Stripped Glass Fabric Glass
Colour	Black/White	Black/White	Black/White	Black/White		Black/White	Black/White	Black/White	Black/White

Optical Accessories



Honeycomb Filter Stripped Glass Fabric Glass

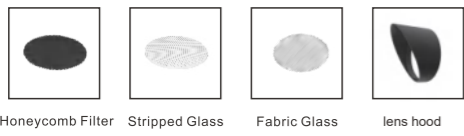
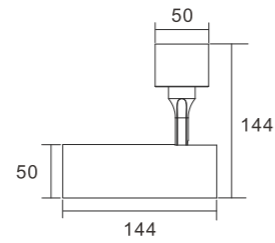
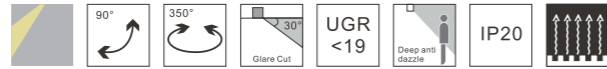
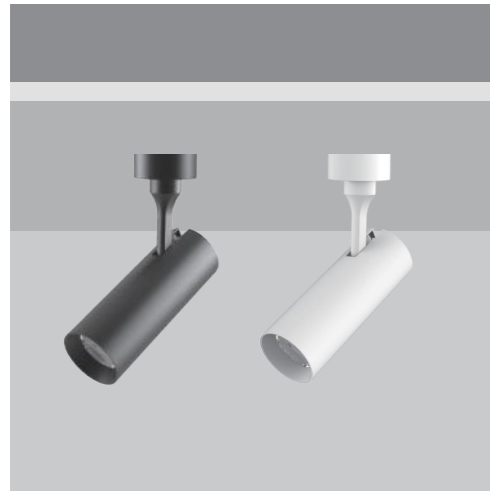

Model	Power	LED voltage	LED Current	CRI	CCT	Beam Angle	LED Output	System output	Dimming Type
KAS-TL10L-D-5007	7W	34V	150mA	90	2700K	10°	835lm	718lm	ON-OFF
						15°	835lm	743lm	
						20°	835lm	760lm	
						30°	835lm	725lm	
KAS-TL10L-D-5008	7W	34V	150mA	90	3000K	10°	860lm	740lm	ON-OFF
						15°	860lm	766lm	
						20°	860lm	783lm	
						30°	860lm	747lm	
KAS-TL10L-D-5009	7W	34V	150mA	90	4000K	10°	872lm	750lm	ON-OFF
						15°	872lm	776lm	
						20°	872lm	793lm	
						30°	872lm	757lm	

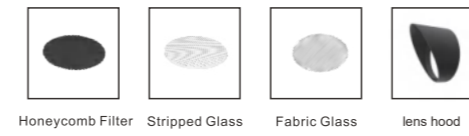
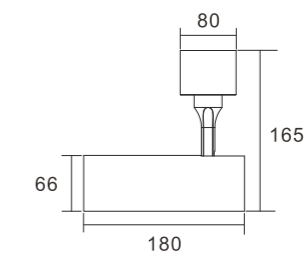
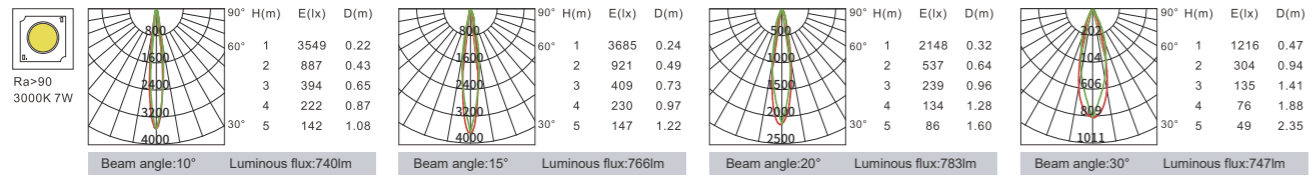

Model	Power	LED voltage	LED Current	CRI	CCT	Beam Angle	LED Output	System output	Dimming Type
KAS-TL10L-D-6610	10W	34V	250mA	90	2700K	10°	1058lm	761lm	ON-OFF TRIAC 1-10V
						15°	1058lm	806lm	
						20°	1058lm	717lm	
						36°	1058lm	790lm	
KAS-TL10L-D-6611	10W	34V	250mA	90	3000K	10°	1099lm	791lm	ON-OFF TRIAC 1-10V
						15°	1099lm	837lm	
						20°	1099lm	745lm	
						36°	1099lm	821lm	
KAS-TL10L-D-6612	10W	34V	250mA	90	4000K	10°	1118lm	804lm	ON-OFF TRIAC 1-10V
						15°	1118lm	851lm	
						20°	1118lm	757lm	
						36°	1118lm	835lm	
KAS-TL10L-D-6615	15W	34V	350mA	90	2700K	10°	1482lm	960lm	ON-OFF TRIAC 1-10V
						15°	1482lm	1031lm	
						20°	1482lm	918lm	
						36°	1482lm	1006lm	
KAS-TL10L-D-6616	15W	34V	350mA	90	3000K	10°	1538lm	997lm	ON-OFF TRIAC 1-10V
						15°	1538lm	1070lm	
						20°	1538lm	953lm	
						36°	1538lm	1045lm	
KAS-TL10L-D-6617	15W	34V	350mA	90	4000K	10°	1564lm	1013lm	ON-OFF TRIAC 1-10V
						15°	1564lm	1080lm	
						20°	1564lm	969lm	
						36°	1564lm	1062lm	

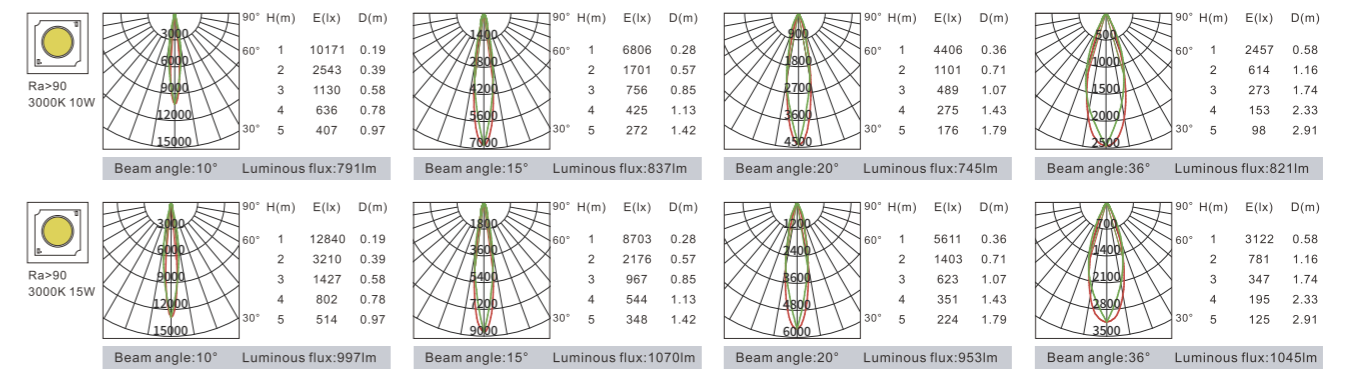

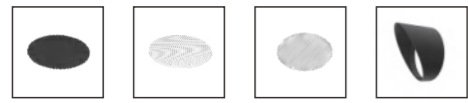
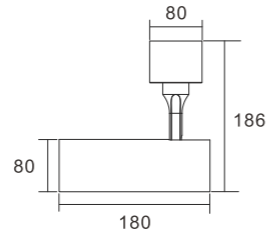

Honeycomb Filter Stripped Glass Fabric Glass lens hood

Model	Power	LED voltage	LED Current	CRI	CCT	Beam Angle	LED Output	System output	Dimming Type
KAS-TL10L-D-8025	25W	34V	600mA	90	2700K	10°	2446lm	1604lm	ON-OFF
						15°	2446lm	1948lm	TRIAC
						20°	2446lm	1809lm	1-10V
						30°	2446lm	1881lm	DALI
	25W	34V	600mA	90	3000K	10°	2545lm	1666lm	ON-OFF
						15°	2545lm	2027lm	TRIAC
						20°	2545lm	1883lm	1-10V
						30°	2545lm	1885lm	DALI
	25W	34V	600mA	90	4000K	10°	2586lm	1692lm	ON-OFF
						15°	2586lm	2059lm	TRIAC
						20°	2586lm	1913lm	1-10V
						30°	2586lm	1915lm	DALI
KAS-TL10L-D-8030	30W	34V	700mA	90	2700K	15°	2853lm	2164lm	ON-OFF
						20°	2853lm	2048lm	TRIAC
						30°	2853lm	2226lm	1-10V
						30°	2853lm	2226lm	DALI
	30W	34V	700mA	90	3000K	15°	2970lm	2253lm	ON-OFF
						20°	2970lm	2133lm	TRIAC
						30°	2970lm	2138lm	1-10V
						30°	2970lm	2138lm	DALI
	30W	34V	700mA	90	4000K	15°	3018lm	2289lm	ON-OFF
						20°	3018lm	2167lm	TRIAC
						30°	3018lm	2170lm	1-10V
						30°	3018lm	2170lm	DALI

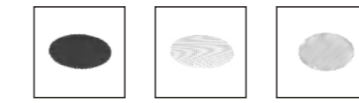
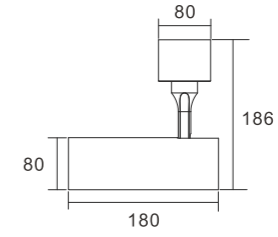
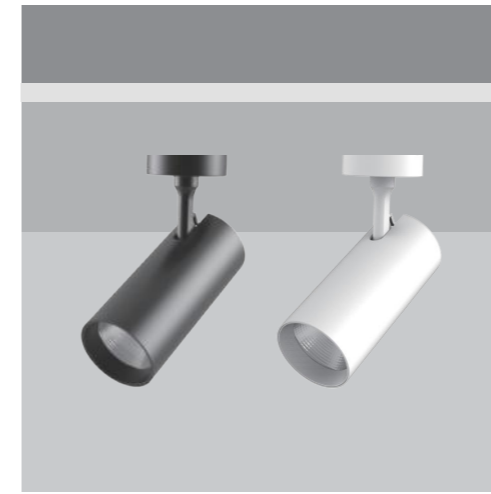
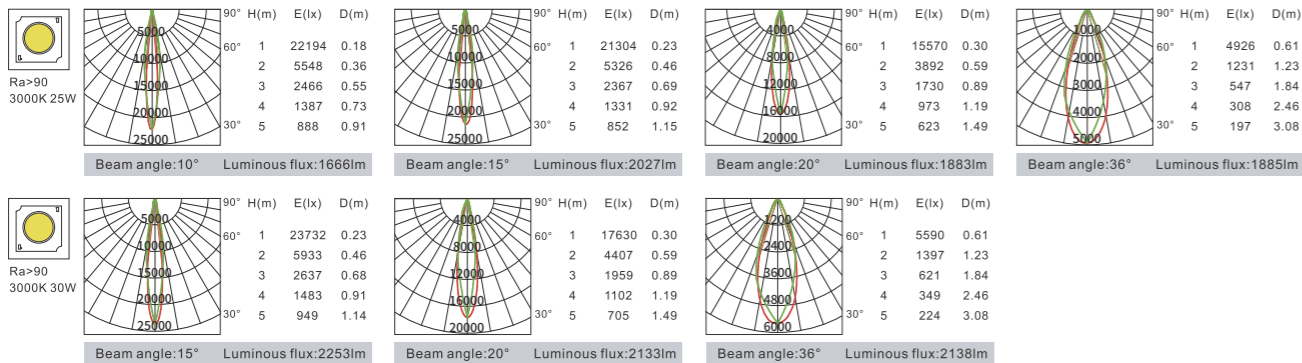

Honeycomb Filter Stripped Glass Fabric Glass

Model	Power	LED voltage	LED Current	CRI	CCT	Beam Angle	LED Output	System output	Dimming Type
KAS-TL10R-D-8025	25W	34V	600mA	90	2700K	20°	2446lm	1864lm	ON-OFF
						24°	2446lm	1840lm	TRIAC
						30°	2446lm	1801lm	1-10V
						36°	2446lm	1862lm	DALI
	25W	34V	600mA	90	3000K	20°	2545lm	1940lm	ON-OFF
						24°	2545lm	1915lm	TRIAC
						30°	2545lm	1874lm	1-10V
						36°	2545lm	1938lm	DALI
	25W	34V	600mA	90	4000K	20°	2586lm	1971lm	ON-OFF
						24°	2586lm	1945lm	TRIAC
						30°	2586lm	1904lm	1-10V
						36°	2586lm	1969lm	DALI
KAS-TL10R-D-8030	30W	34V	700mA	90	2700K	20°	2853lm	2115lm	ON-OFF
						24°	2853lm	2088lm	TRIAC
						30°	2853lm	2046lm	1-10V
						36°	2853lm	2084lm	DALI
	30W	34V	700mA	90	3000K	20°	2970lm	2202lm	ON-OFF
						24°	2970lm	2174lm	TRIAC
						30°	2970lm	2130lm	1-10V
						36°	2970lm	2170lm	DALI
	30W	34V	700mA	90	4000K	20°	3018lm	2237lm	ON-OFF
						24°	3018lm	2209lm	TRIAC
						30°	3018lm	2164lm	1-10V
						36°	3018lm	2205lm	DALI

