

IP65
UGR<19

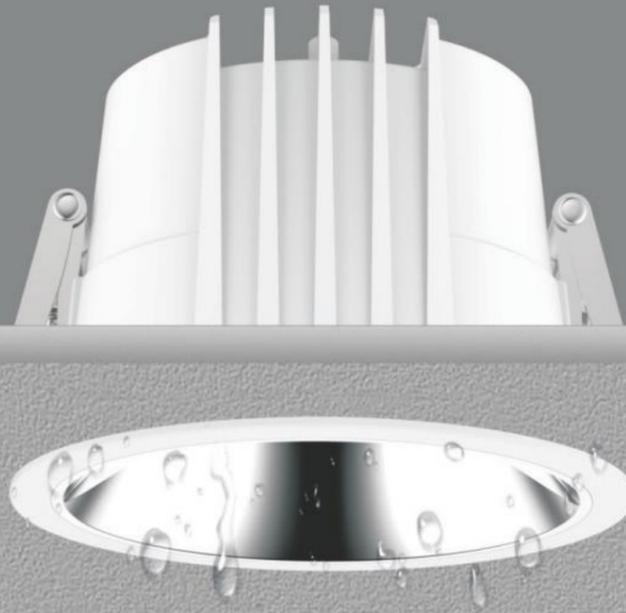

Recessed downlight, optional size 3", 4", 5", 6", and 8".
Die-casting aluminum lamp body and face ring.
Reasonable inner structure, firm and reliable, easy for installation.
IP65 available



- High brightness LED COB with Ra>90, the lighting efficiency of the whole lamp is more than 80lm/w.
- Different cutout sizes for options, to meet different needs.
- Heat dissipation structure with die casting aluminum conduct heat effectively and quickly to guarantee the normal lifespan of the LED.

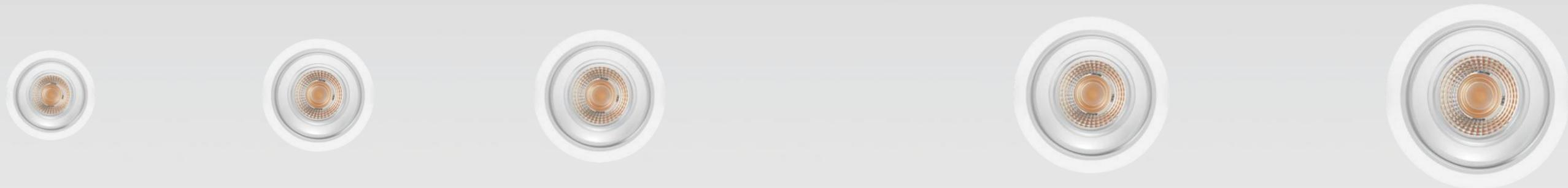
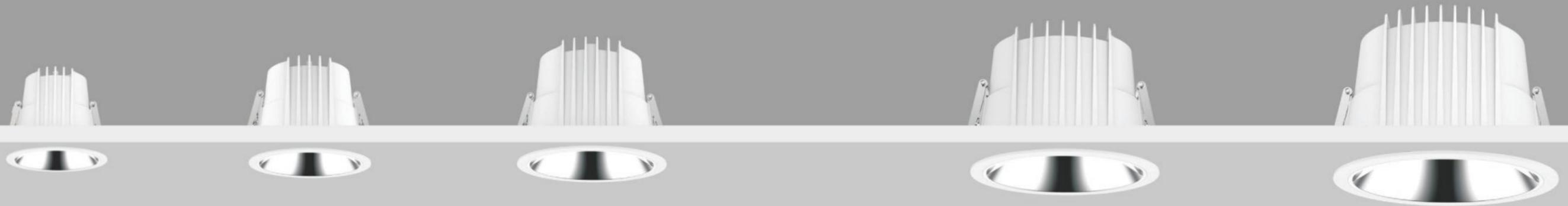

KS-DL07L-A-3
Power: 8W/10W
Cutout: 75mm
Height: 71mm

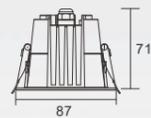

KS-DL07L-A-4
Power: 12W/15W
Cutout: 100mm
Height: 80mm

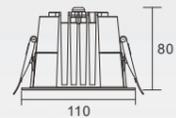

KS-DL07L-A-5
Power: 20W/25W
Cutout: 125mm
Height: 96mm

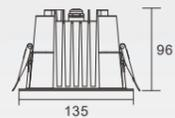

KS-DL07L-A-6
Power: 25W/30W/35W
Cutout: 150mm
Height: 110mm

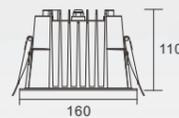

KS-DL07L-A-7
Power: 35W/40W/45W
Cutout: 175mm
Height: 121mm

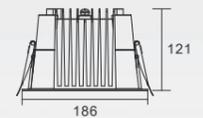

Model	KS-DL07L-A-3	KS-DL07L-A-4	KS-DL07L-A-5	KS-DL07L-A-6	KS-DL07L-A-7
Product Photo					
Dimension(mm)					
Cutout(mm)	75	100	125	150	175
Wattage	8W/10W	12W/15W	20W/25W	25W/30W/35W	35W/40W/45W
CCT	2700K/3000K/3500K/4000K	2700K/3000K/3500K/4000K	2700K/3000K/3500K/4000K	2700K/3000K/3500K/4000K	2700K/3000K/3500K/4000K
CRI	>90	>90	>90	>90	>90
Beam Angle	24°/50°	24°/50°	24°/50°	24°/50°	24°/50°
Lumen	580-750LM	900-1100LM	1500-1800LM	1800-2500LM	2900-3500LM
IP	IP44/IP65	IP44/IP65	IP44/IP65	IP44/IP65	IP44/IP65
Dimming	TRIAC/1-10V/DALI	TRIAC/1-10V/DALI	TRIAC/1-10V/DALI	TRIAC/1-10V/DALI	TRIAC/1-10V/DALI
Accessory	Honeycomb Filter Fabric Glass	Honeycomb Filter Fabric Glass	Honeycomb Filter Fabric Glass	Honeycomb Filter Fabric Glass	Honeycomb Filter Fabric Glass
Colour	White	White	White	White	White

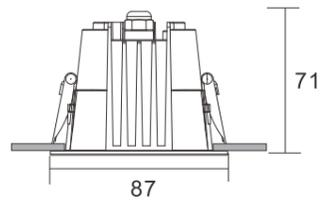

∅ 75

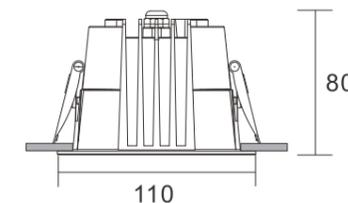
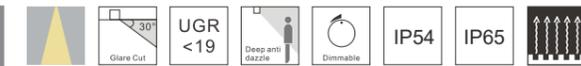

∅ 100

Model	Power	LED voltage	LED Current	CRI	CCT	Beam Angle	LED Output	System output	Dimming Type
KS-DL07L-A-308	8W	36V	200mA	90	2700K	24° 50°	740lm 740lm	537lm 514lm	ON-OFF TRIAC 1-10V DALI
	8W	36V	200mA	90	3000K	24° 50°	805lm 805lm	584lm 560lm	ON-OFF TRIAC 1-10V DALI
	8W	36V	200mA	90	4000K	24° 50°	850lm 850lm	616lm 700lm	ON-OFF TRIAC 1-10V DALI
KS-DL07L-A-310	10W	36V	250mA	90	2700K	24° 50°	920lm 920lm	720lm 706lm	ON-OFF TRIAC 1-10V DALI
	10W	36V	250mA	90	3000K	24° 50°	950lm 950lm	750lm 730lm	ON-OFF TRIAC 1-10V DALI
	10W	36V	250mA	90	4000K	24° 50°	1005lm 1005lm	793lm 772lm	ON-OFF TRIAC 1-10V DALI

Model	Power	LED voltage	LED Current	CRI	CCT	Beam Angle	LED Output	System output	Dimming Type
KS-DL07L-A-412	12W	36V	300mA	90	2700K	24° 50°	1080lm 1080lm	857lm 837lm	ON-OFF TRIAC 1-10V DALI
	12W	36V	300mA	90	3000K	24° 50°	1130lm 1130lm	897lm 876lm	ON-OFF TRIAC 1-10V DALI
	12W	36V	300mA	90	4000K	24° 50°	1180lm 1180lm	936lm 914lm	ON-OFF TRIAC 1-10V DALI
KS-DL07L-A-415	15W	36V	350mA	90	2700K	24° 50°	1230lm 1230lm	1064lm 1036lm	ON-OFF TRIAC 1-10V DALI
	15W	36V	350mA	90	3000K	24° 50°	1300lm 1300lm	1125lm 1095lm	ON-OFF TRIAC 1-10V DALI
	15W	36V	350mA	90	4000K	24° 50°	1365lm 1365lm	1181lm 1149lm	ON-OFF TRIAC 1-10V DALI

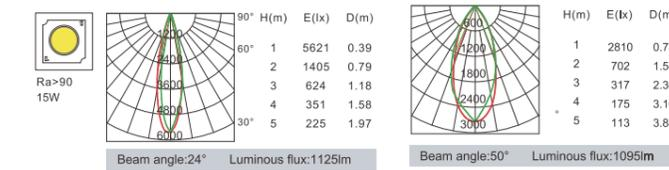
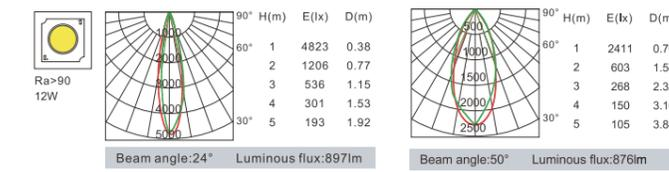
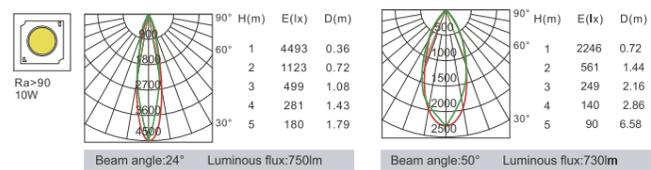

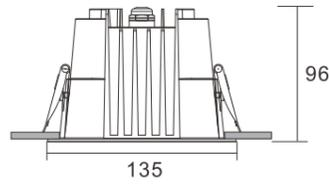

⌀ 125

Model	Power	LED voltage	LED Current	CRI	CCT	Beam Angle	LED Output	System output	Dimming Type
KS-DL07L-A-520	20W	36V	500mA	90	2700K	24° 50°	1950lm 1950lm	1346lm 1375lm	ON-OFF TRIAC 1-10V DALI
	20W	36V	500mA	90	3000K	24° 50°	2070lm 2070lm	1429lm 1460lm	ON-OFF TRIAC 1-10V DALI
	20W	36V	500mA	90	4000K	24° 50°	2200lm 2200lm	1518lm 1551lm	ON-OFF TRIAC 1-10V DALI
KS-DL07L-A-525	25W	36V	600mA	90	2700K	24° 50°	2320lm 2320lm	1638lm 1707lm	ON-OFF TRIAC 1-10V DALI
	25W	36V	600mA	90	3000K	24° 50°	2480lm 2480lm	1752lm 1825lm	ON-OFF TRIAC 1-10V DALI
	25W	36V	600mA	90	4000K	24° 50°	2590lm 2590lm	1829lm 1905lm	ON-OFF TRIAC 1-10V DALI

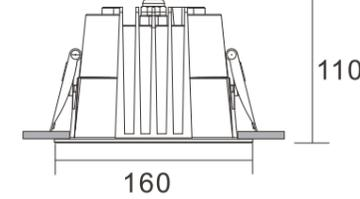
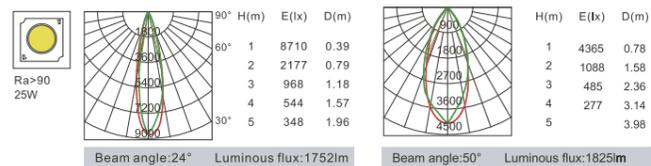
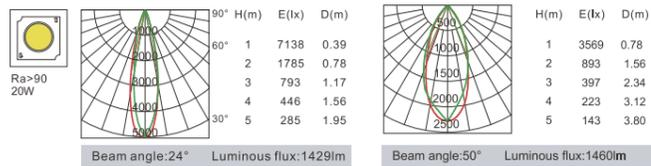

⌀ 150

Model	Power	LED voltage	LED Current	CRI	CCT	Beam Angle	LED Output	System output	Dimming Type
KS-DL07L-A-625	25W	36V	600mA	90	2700K	24° 50°	2320lm 2320lm	1617lm 1637lm	ON-OFF TRIAC 1-10V DALI
	25W	36V	600mA	90	3000K	24° 50°	2480lm 2480lm	1729lm 1750lm	ON-OFF TRIAC 1-10V DALI
	25W	36V	600mA	90	4000K	24° 50°	2590lm 2590lm	1805lm 1827lm	ON-OFF TRIAC 1-10V DALI
KS-DL07L-A-630	30W	36V	700mA	90	2700K	24° 50°	2650lm 2650lm	1942lm 1980lm	ON-OFF TRIAC 1-10V DALI
	30W	36V	700mA	90	3000K	24° 50°	2890lm 2890lm	2118lm 2160lm	ON-OFF TRIAC 1-10V DALI
	30W	36V	700mA	90	4000K	24° 50°	3000lm 3000lm	2198lm 2242lm	ON-OFF TRIAC 1-10V DALI
KS-DL07L-A-635	35W	36V	900mA	90	2700K	24° 50°	3020lm 3020lm	2309lm 2356lm	ON-OFF TRIAC 1-10V DALI
	35W	36V	900mA	90	3000K	24° 50°	3230lm 3230lm	2470lm 2520lm	ON-OFF TRIAC 1-10V DALI
	35W	36V	900mA	90	4000K	24° 50°	3600lm 3600lm	2752lm 2808lm	ON-OFF TRIAC 1-10V DALI

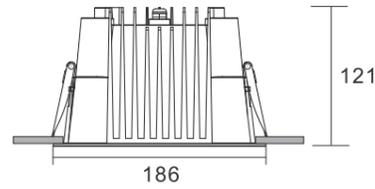

Ø 175



Model	Power	LED voltage	LED Current	CRI	CCT	Beam Angle	LED Output	System output	Dimming Type
KS-DL07L-A-735	35W	36V	900mA	90	2700K	24° 50°	3020lm 3020lm	2454lm 2384lm	ON-OFF TRIAC 1-10V DALI
	35W	36V	900mA	90	3000K	24° 50°	3230lm 3230lm	2625lm 2550lm	ON-OFF TRIAC 1-10V DALI
	35W	36V	900mA	90	4000K	24° 50°	3600lm 3600lm	2925lm 2842lm	ON-OFF TRIAC 1-10V DALI
KS-DL07L-A-740	40W	36V	1000mA	90	2700K	24° 50°	3920lm 3920lm	2887lm 2764lm	ON-OFF TRIAC 1-10V DALI
	40W	36V	1000mA	90	3000K	24° 50°	4140lm 4140lm	3050lm 2920lm	ON-OFF TRIAC 1-10V DALI
	40W	36V	1000mA	90	4000K	24° 50°	4500lm 4500lm	3315lm 3173lm	ON-OFF TRIAC 1-10V DALI
KS-DL07L-A-745	45W	36V	1200mA	90	2700K	24° 50°	3970lm 3970lm	3162lm 3075lm	ON-OFF TRIAC 1-10V DALI
	45W	36V	1200mA	90	3000K	24° 50°	4240lm 4240lm	3378lm 3285lm	ON-OFF TRIAC 1-10V DALI
	45W	36V	1200mA	90	4000K	24° 50°	4720lm 4720lm	3760lm 3656lm	ON-OFF TRIAC 1-10V DALI

- High brightness LED SMD with Ra>90, the lighting efficiency of the whole lamp is more than 90lm/w.
- Different cutout sizes for options, to meet different needs.
- Heat dissipation structure with die casting aluminum conduct heat effectively and quickly to guarantee the normal lifespan of the LED.

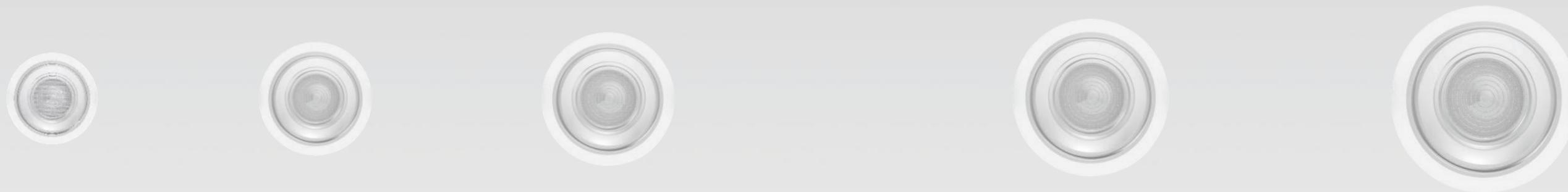

KS-DL07L-B-3
Power: 8W/10W
Cutout: 75mm
Height: 71mm

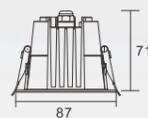

KS-DL07L-B-4
Power: 12W/15W
Cutout: 100mm
Height: 80mm

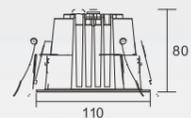

KS-DL07L-B-5
Power: 20W/25W
Cutout: 125mm
Height: 96mm

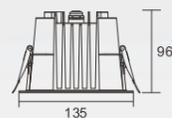

KS-DL07L-B-6
Power: 25W/30W/35W
Cutout: 150mm
Height: 110mm

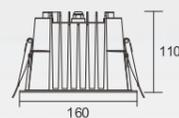

KS-DL07L-B-7
Power: 35W/40W/45W
Cutout: 175mm
Height: 121mm

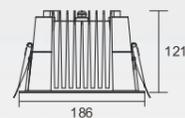

Model	KS-DL07L-B-3	KS-DL07L-B-4	KS-DL07L-B-5	KS-DL07L-B-6	KS-DL07L-B-7
Product Photo					
Dimension(mm)					
Cutout(mm)	75	100	125	150	175
Wattage	8W/10W	12W/15W	20W/25W	25W/30W/35W	35W/40W/45W
CCT	2700K/3000K/3500K/4000K	2700K/3000K/3500K/4000K	2700K/3000K/3500K/4000K	2700K/3000K/3500K/4000K	2700K/3000K/3500K/4000K
CRI	>90	>90	>90	>90	>90
Beam Angle	60°	60°	60°	60°	60°
Lumen	600-710LM	980-1200LM	1700-2250LM	2250-3350LM	3350-4200LM
IP	IP44/IP65	IP44/IP65	IP44/IP65	IP44/IP65	IP44/IP65
Dimming	TRIAC/1-10V/DALI	TRIAC/1-10V/DALI	TRIAC/1-10V/DALI	TRIAC/1-10V/DALI	TRIAC/1-10V/DALI
Accessory	Honeycomb Filter Fabric Glass	Honeycomb Filter Fabric Glass	Honeycomb Filter Fabric Glass	Honeycomb Filter Fabric Glass	Honeycomb Filter Fabric Glass
Colour	White	White	White	White	White

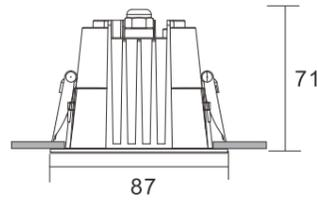

75

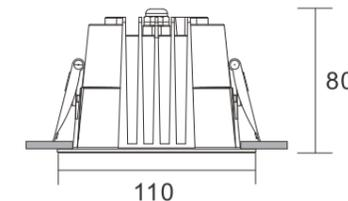
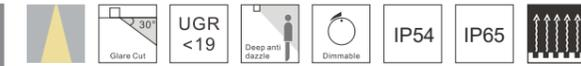

100

Model	Power	LED voltage	LED Current	CRI	CCT	Beam Angle	LED Output	System output	Dimming Type
KS-DL07L-B-308	8W	36V	200mA	90	2700K	60°	740lm	545lm	ON-OFF TRIAC 1-10V DALI
	8W	36V	200mA	90	3000K	60°	805lm	593lm	ON-OFF TRIAC 1-10V DALI
	8W	36V	200mA	90	4000K	60°	850lm	626lm	ON-OFF TRIAC 1-10V DALI
KS-DL07L-B-310	10W	36V	250mA	90	2700K	60°	920lm	689lm	ON-OFF TRIAC 1-10V DALI
	10W	36V	250mA	90	3000K	60°	950lm	712lm	ON-OFF TRIAC 1-10V DALI
	10W	36V	250mA	90	4000K	60°	1005lm	753lm	ON-OFF TRIAC 1-10V DALI

Model	Power	LED voltage	LED Current	CRI	CCT	Beam Angle	LED Output	System output	Dimming Type
KS-DL07L-B-412	12W	36V	300mA	90	2700K	60°	1080lm	931lm	ON-OFF TRIAC 1-10V DALI
	12W	36V	300mA	90	3000K	60°	1130lm	975lm	ON-OFF TRIAC 1-10V DALI
	12W	36V	300mA	90	4000K	60°	1180lm	1018lm	ON-OFF TRIAC 1-10V DALI
KS-DL07L-B-415	15W	36V	350mA	90	2700K	60°	1230lm	1103lm	ON-OFF TRIAC 1-10V DALI
	15W	36V	350mA	90	3000K	60°	1300lm	1018lm	ON-OFF TRIAC 1-10V DALI
	15W	36V	350mA	90	4000K	60°	1365lm	1224lm	ON-OFF TRIAC 1-10V DALI

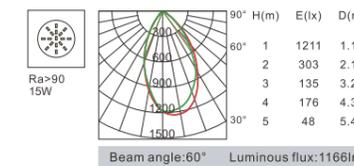
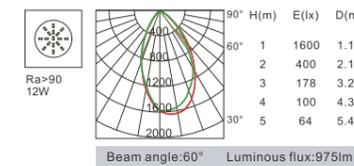
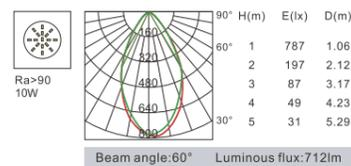
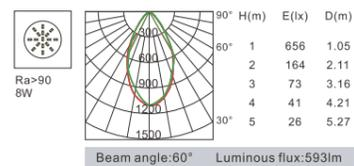

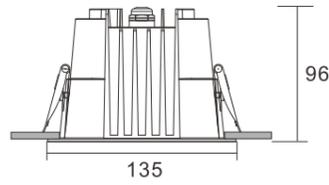

∅ 125

Model	Power	LED voltage	LED Current	CRI	CCT	Beam Angle	LED Output	System output	Dimming Type
KS-DL07L-B-520	20W	36V	500mA	90	2700K	60°	1950lm	1590lm	ON-OFF TRIAC 1-10V DALI
	20W	36V	500mA	90	3000K	60°	2070lm	1688lm	ON-OFF TRIAC 1-10V DALI
	20W	36V	500mA	90	4000K	60°	2200lm	1794lm	ON-OFF TRIAC 1-10V DALI
KS-DL07L-B-525	25W	36V	600mA	90	2700K	60°	2320lm	2080lm	ON-OFF TRIAC 1-10V DALI
	25W	36V	600mA	90	3000K	60°	2480lm	2224lm	ON-OFF TRIAC 1-10V DALI
	25W	36V	600mA	90	4000K	60°	2590lm	2322lm	ON-OFF TRIAC 1-10V DALI

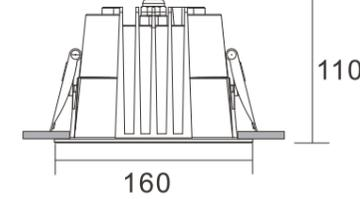
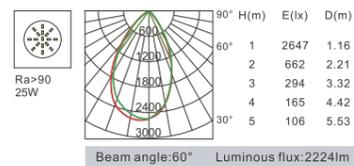
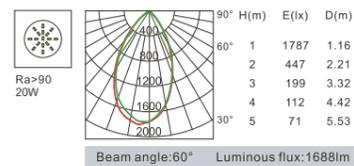

∅ 150

Model	Power	LED voltage	LED Current	CRI	CCT	Beam Angle	LED Output	System output	Dimming Type
KS-DL07L-B-625	25W	36V	600mA	90	2700K	60°	2320lm	2080lm	ON-OFF TRIAC 1-10V DALI
	25W	36V	600mA	90	3000K	60°	2480lm	2224lm	ON-OFF TRIAC 1-10V DALI
	25W	36V	600mA	90	4000K	60°	2590lm	2322lm	ON-OFF TRIAC 1-10V DALI
KS-DL07L-B-630	30W	36V	700mA	90	2700K	60°	2650lm	2339lm	ON-OFF TRIAC 1-10V DALI
	30W	36V	700mA	90	3000K	60°	2890lm	2551lm	ON-OFF TRIAC 1-10V DALI
	30W	36V	700mA	90	4000K	60°	3000lm	2648lm	ON-OFF TRIAC 1-10V DALI
KS-DL07L-B-635	35W	36V	900mA	90	2700K	60°	3020lm	3133lm	ON-OFF TRIAC 1-10V DALI
	35W	36V	900mA	90	3000K	60°	3000lm	2648lm	ON-OFF TRIAC 1-10V DALI
	35W	36V	900mA	90	4000K	60°	3600lm	3734lm	ON-OFF TRIAC 1-10V DALI

DL07 Series

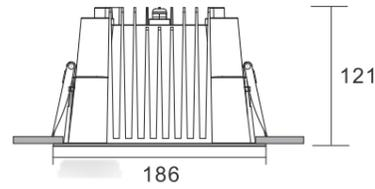

⌀ 175

Model	Power	LED voltage	LED Current	CRI	CCT	Beam Angle	LED Output	System output	Dimming Type
KS-DL07L-B-735	35W	36V	900mA	90	2700K	60°	3322lm	3133lm	ON-OFF TRIAC 1-10V DALI
	35W	36V	900mA	90	3000K	60°	3553lm	3351lm	ON-OFF TRIAC 1-10V DALI
	35W	36V	900mA	90	4000K	60°	3960lm	3734lm	ON-OFF TRIAC 1-10V DALI
KS-DL07L-B-740	40W	36V	1000mA	90	2700K	60°	3920lm	3093lm	ON-OFF TRIAC 1-10V DALI
	40W	36V	1000mA	90	3000K	60°	4140lm	3267lm	ON-OFF TRIAC 1-10V DALI
	40W	36V	1000mA	90	4000K	60°	4500lm	3551lm	ON-OFF TRIAC 1-10V DALI
KS-DL07L-B-745	45W	36V	1200mA	90	2700K	60°	3970lm	3903lm	ON-OFF TRIAC 1-10V DALI
	45W	36V	1200mA	90	3000K	60°	4240lm	4169lm	ON-OFF TRIAC 1-10V DALI
	45W	36V	1200mA	90	4000K	60°	4720lm	4640lm	ON-OFF TRIAC 1-10V DALI



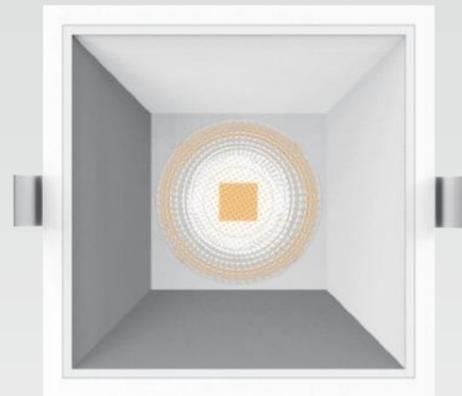

- Outstanding color rendition effect, meet the lighting demand of upscale places. 2700K/3000K/4000K, Ra>90
- Dark light technology with chip deeply hidden, well-designed dark light reflector with UGR≤19. Comfortable and no glare.
- Die-casting aluminium heat sink, conducts the heat from the chip effectively, and ensure the lamp performance and long lifespan.
- Precise distribution and even transition. Less scattering makes vision more comfortable.



KAS-DL07P-S-3
Power: 10W/15W
Cutout: 90*90mm
Height: 64mm

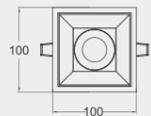
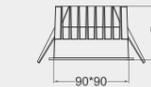

KAS-DL07P-S-4
Power: 15W/20W
Cutout: 125*125mm
Height: 83mm

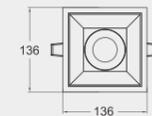

KAS-DL07P-S-5
Power: 25W/30W
Cutout: 145*145mm
Height: 96mm

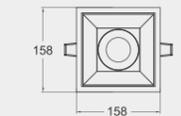

KAS-DL07P-S-6
Power: 30W/40W/50W
Cutout: 165*165mm
Height: 109mm

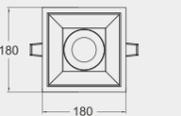

Model	KAS-DL07P-S-3	KAS-DL07P-S-4	KAS-DL07P-S-5	KAS-DL07P-S-6
Product Photo				
Dimension(mm)				
Cutout(mm)	90*90	125*125	145*145	165*165
Wattage	10W/15W	15W/20W	25W/30W	30W/40W/50W
CCT	2700K 3000K 3500K 4000K	2700K 3000K 3500K 4000K	2700K 3000K 3500K 4000K	2700K 3000K 3500K 4000K
CRI	>90	>90	>90	>90
Beam Angle	18°/24°/36°/50°	18°/24°/36°/55°	18°/24°/36°/60°	18°/24°/36°/60°
Lumen	1168LM	1833LM	2229LM	3036LM
IP	IP65	IP65	IP65	IP65
Dimming	TRIAC/1-10V/DALI	TRIAC/1-10V/DALI	TRIAC/1-10V/DALI	TRIAC/1-10V/DALI
Reflector Colour	Highly specular aluminium UV processed black cup Gold	Highly specular aluminium UV processed black cup Gold	Highly specular aluminium UV processed black cup Gold	Highly specular aluminium UV processed black cup Gold
Colour	White	White	White	White

Reflecting Accessories



Highly specular aluminium UV processed black cup Gold

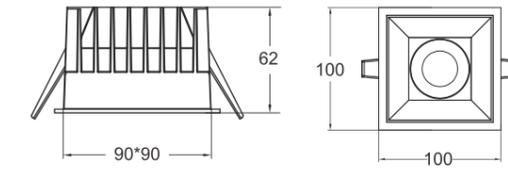
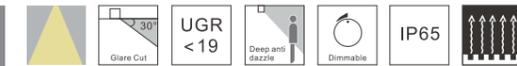

90*90mm

Model	Power	LED voltage	LED Current	CRI	CCT	Beam Angle	LED Output	System output	Dimming Type
KAS-DL07P-S-310	10W	36V	250mA	90	2700K	18°	927lm	1124lm	ON-OFF
						24°	927lm	1012lm	TRIAC
						36°	927lm	1119lm	1-10V
						50°	927lm	1160lm	DALI
KAS-DL07P-S-310	10W	36V	250mA	90	3000K	18°	963lm	1168lm	ON-OFF
						24°	963lm	1052lm	TRIAC
						36°	963lm	1163lm	1-10V
						50°	963lm	1206lm	DALI
KAS-DL07P-S-310	10W	36V	250mA	90	4000K	18°	1008lm	1222lm	ON-OFF
						24°	1008lm	1101lm	TRIAC
						36°	1008lm	1217lm	1-10V
						50°	1008lm	1262lm	DALI
KAS-DL07P-S-315	15W	36V	350mA	90	2700K	18°	1297lm	1128lm	ON-OFF
						24°	1297lm	1017lm	TRIAC
						36°	1297lm	1134lm	1-10V
						50°	1297lm	1250lm	DALI
KAS-DL07P-S-315	15W	36V	350mA	90	3000K	18°	1348lm	1173lm	ON-OFF
						24°	1348lm	1058lm	TRIAC
						36°	1348lm	1179lm	1-10V
						50°	1348lm	1300lm	DALI
KAS-DL07P-S-315	15W	36V	350mA	90	4000K	18°	1411lm	1227m	ON-OFF
						24°	1411lm	1107lm	TRIAC
						36°	1411lm	1234lm	1-10V
						50°	1411lm	1360lm	DALI

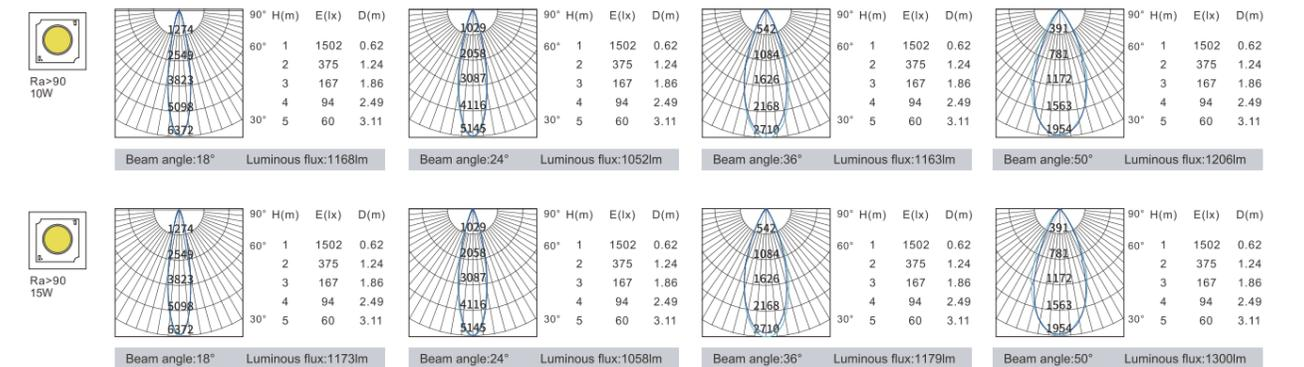

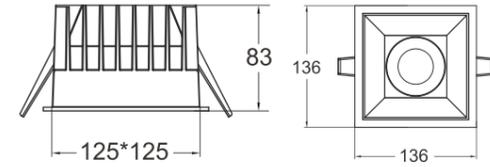
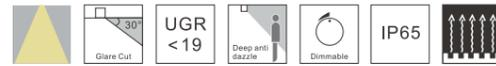

125*125mm

Model	Power	LED voltage	LED Current	CRI	CCT	Beam Angle	LED Output	System output	Dimming Type
KAS-DL07P-S-415	15W	36V	350mA	90	2700K	18°	1945lm	1763lm	ON-OFF
						24°	1945lm	1756lm	TRIAC
						36°	1945lm	1839lm	1-10V
						55°	1945lm	1912lm	DALI
	15W	36V	350mA	90	3000K	18°	2022lm	1833lm	ON-OFF
						24°	2022lm	1826lm	TRIAC
						36°	2022lm	1912lm	1-10V
						55°	2022lm	1988lm	DALI
	15W	36V	350mA	90	4000K	18°	2116lm	1918lm	ON-OFF
						24°	2116lm	1911lm	TRIAC
						36°	2116lm	2001lm	1-10V
						55°	2116lm	2080lm	DALI
KAS-DL07P-S-420	20W	36V	500mA	90	2700K	18°	2781lm	1775lm	ON-OFF
						24°	2781lm	1767lm	TRIAC
						36°	2781lm	1850lm	1-10V
						55°	2781lm	1924lm	DALI
	20W	36V	500mA	90	3000K	18°	2889lm	1844lm	ON-OFF
						24°	2889lm	1836lm	TRIAC
						36°	2889lm	1922lm	1-10V
						55°	2889lm	1999lm	DALI
	20W	36V	500mA	90	4000K	18°	3024lm	1930lm	ON-OFF
						24°	3024lm	1921lm	TRIAC
						36°	3024lm	2011lm	1-10V
						55°	3024lm	2092lm	DALI

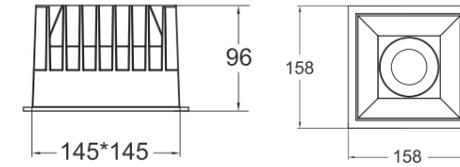
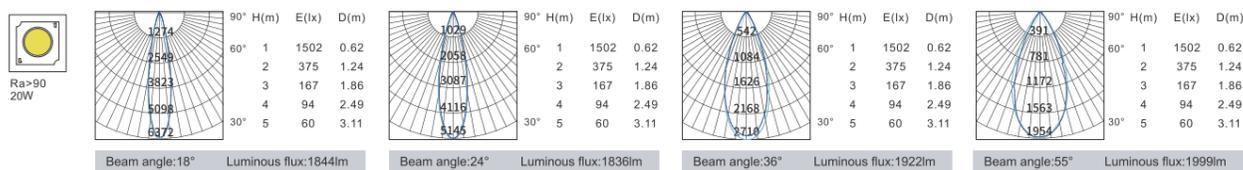
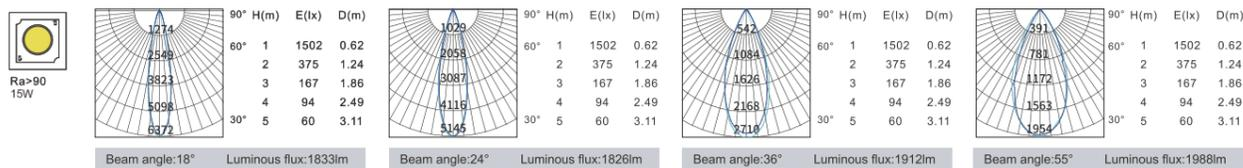

145*145mm

Model	Power	LED voltage	LED Current	CRI	CCT	Beam Angle	LED Output	System output	Dimming Type
KAS-DL07P-S-525	25W	36V	600mA	90	2700K	18°	2892lm	2146lm	ON-OFF
						24°	2892lm	2561lm	TRIAC
						36°	2892lm	2445lm	1-10V
						60°	2892lm	2461lm	DALI
	25W	36V	600mA	90	3000K	18°	3004lm	2229lm	ON-OFF
						24°	3004lm	2660lm	TRIAC
						36°	3004lm	2540lm	1-10V
						60°	3004lm	2557lm	DALI
	25W	36V	600mA	90	4000K	18°	3144lm	2129lm	ON-OFF
						24°	3144lm	2784lm	TRIAC
						36°	3144lm	2658lm	1-10V
						60°	3144lm	2676lm	DALI
KAS-DL07P-S-530	30W	36V	700mA	90	2700K	18°	3373lm	2155lm	ON-OFF
						24°	3373lm	2595lm	TRIAC
						36°	3373lm	2454lm	1-10V
						60°	3373lm	2470lm	DALI
	30W	36V	700mA	90	3000K	18°	3504lm	2239lm	ON-OFF
						24°	3504lm	2670lm	TRIAC
						36°	3504lm	2550lm	1-10V
						60°	3504lm	2567lm	DALI
	30W	36V	700mA	90	4000K	18°	3668lm	2343lm	ON-OFF
						24°	3668lm	2794lm	TRIAC
						36°	3668lm	2669lm	1-10V
						60°	3668lm	2686lm	DALI

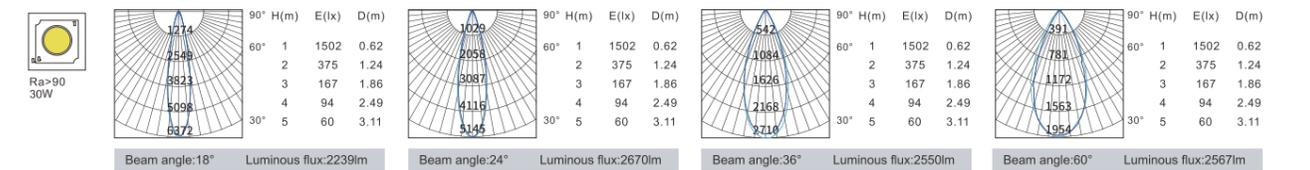
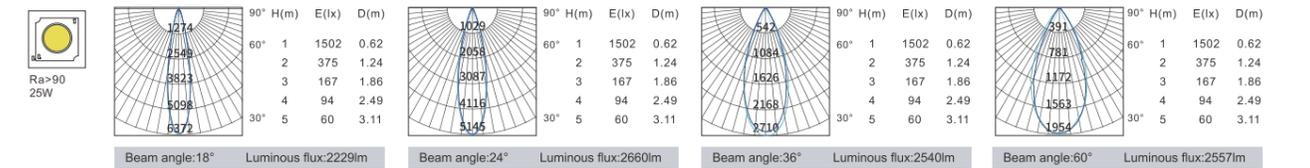

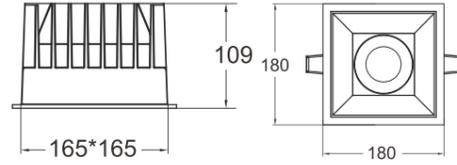

165*165mm

Model	Power	LED voltage	LED Current	CRI	CCT	Beam Angle	LED Output	System output	Dimming Type
KAS-DL07P-S-630	30W	36V	700mA	90	2700K	18°	3373lm	2920lm	ON-OFF
						24°	3373lm	3225lm	TRIAC
						36°	3373lm	2980lm	1-10V
						60°	3373lm	2868lm	DALI
	30W	36V	700mA	90	3000K	18°	3504lm	3034lm	ON-OFF
						24°	3504lm	3351lm	TRIAC
						36°	3504lm	3096lm	1-10V
						60°	3504lm	2980lm	DALI
	30W	36V	700mA	90	4000K	18°	3668lm	3176lm	ON-OFF
						24°	3668lm	3507lm	TRIAC
						36°	3668lm	3240lm	1-10V
						60°	3668lm	3119lm	DALI
KAS-DL07P-S-640	40W	36V	900mA	90	2700K	18°	3708lm	2922lm	ON-OFF
						24°	3708lm	3365lm	TRIAC
						36°	3708lm	3578lm	1-10V
						60°	3708lm	3443lm	DALI
	40W	36V	900mA	90	3000K	18°	3852lm	3036lm	ON-OFF
						24°	3852lm	3496lm	TRIAC
						36°	3852lm	3717lm	1-10V
						60°	3852lm	3577lm	DALI
	40W	36V	900mA	90	4000K	18°	4032lm	3177lm	ON-OFF
						24°	4032lm	3659lm	TRIAC
						36°	4032lm	3890lm	1-10V
						60°	4032lm	3744lm	DALI
KAS-DL07P-S-645	45W	36V	1200mA	90	2700K	18°	4449lm	2931lm	ON-OFF
						24°	4449lm	2386lm	TRIAC
						36°	4449lm	3587lm	1-10V
						60°	4449lm	3449lm	DALI
	45W	36V	1200mA	90	3000K	18°	4622lm	3046lm	ON-OFF
						24°	4622lm	2479lm	TRIAC
						36°	4622lm	3727lm	1-10V
						60°	4622lm	3584lm	DALI
	45W	36V	1200mA	90	4000K	18°	4838lm	3188lm	ON-OFF
						24°	4838lm	2594lm	TRIAC
						36°	4838lm	3901lm	1-10V
						60°	4838lm	3751lm	DALI



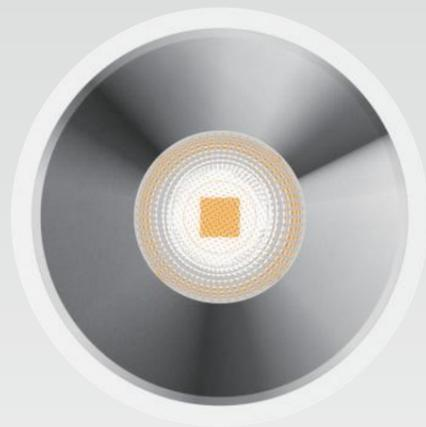

- Outstanding color rendition effect, meet the lighting demand of upscale places. 2700K/3000K/4000K, Ra>90
- Dark light technology with chip deeply hidden, well-designed dark light reflector with UGR≤19. Comfortable and no glare.
- Die-casting aluminium heat sink, conducts the heat from the chip effectively, and ensure the lamp performance and long lifespan.
- Precise distribution and even transition. Less scattering makes vision more comfortable.



KAS-DL07P-R-3
Power: 10W/15W
Output: 90mm
Height: 64mm

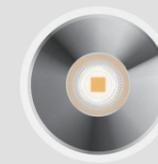
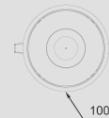
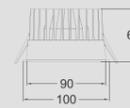

KAS-DL07P-R-4
Power: 15W/20W
Output: 125mm
Height: 83mm

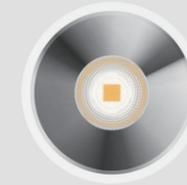
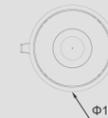
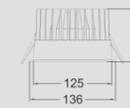

KAS-DL07P-R-5
Power: 25W/30W
Output: 145mm
Height: 96mm

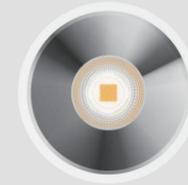
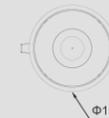
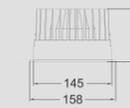

KAS-DL07P-R-6
Power: 30W/40W
Output: 165mm
Height: 109mm

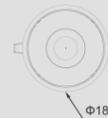
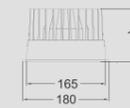

Model	KAS-DL07P-R-3	KAS-DL07P-R-4	KAS-DL07P-R-5	KAS-DL07P-R-6
Product Photo				
Dimension(mm)				
Cutout(mm)	90	125	145	165
Wattage	10W/15W	15W/20W	25W/30W	30W/40W
CCT	2700K 3000K 3500K 4000K	2700K 3000K 3500K 4000K	2700K 3000K 3500K 4000K	2700K 3000K 3500K 4000K
CRI	>90	>90	>90	>90
Beam Angle	18°/24°/36°/50°	18°/24°/36°/55°	18°/24°/36°/60°	18°/24°/36°/60°
Lumen	1168LM	1833LM	2229LM	3036LM
IP	IP65	IP65	IP65	IP65
Dimming	TRIAC/1-10V/DALI	TRIAC/1-10V/DALI	TRIAC/1-10V/DALI	TRIAC/1-10V/DALI
Reflector Colour	Highly specular aluminium UV processed black cup Gold	Highly specular aluminium UV processed black cup Gold	Highly specular aluminium UV processed black cup Gold	Highly specular aluminium UV processed black cup Gold
Colour	White	White	White	White

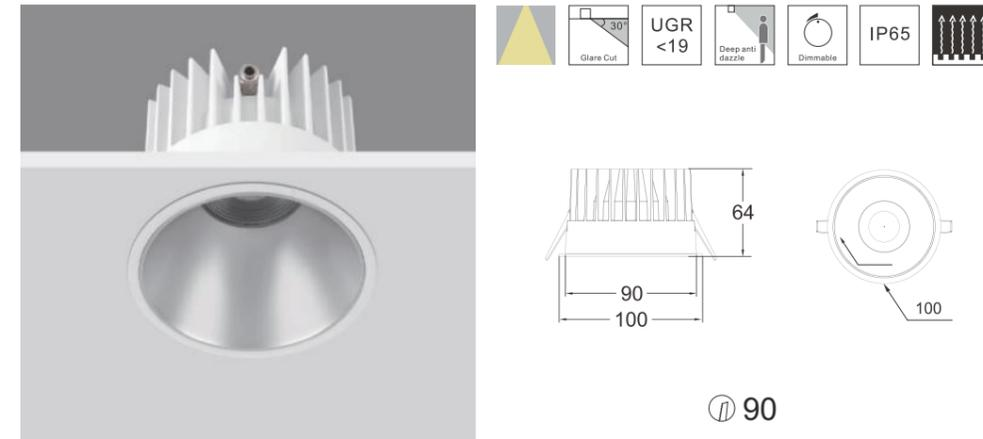

Model	Power	LED voltage	LED Current	CRI	CCT	Beam Angle	LED Output	System output	Dimming Type
KAS-DL07P-R-310	10W	36V	250mA	90	2700K	18°	927lm	787lm	ON-OFF
						24°	927lm	880lm	TRIAC
						36°	927lm	894lm	1-10V
						50°	927lm	943lm	DALI
	10W	36V	250mA	90	3000K	18°	963lm	818lm	ON-OFF
						24°	963lm	915lm	TRIAC
						36°	963lm	929lm	1-10V
						50°	963lm	980lm	DALI
	10W	36V	250mA	90	4000K	18°	1008lm	856lm	ON-OFF
						24°	1008lm	957lm	TRIAC
						36°	1008lm	972lm	1-10V
						50°	1008lm	1025lm	DALI
KAS-DL07P-R-315	15W	36V	350mA	90	2700K	18°	1297lm	941lm	ON-OFF
						24°	1297lm	1149lm	TRIAC
						36°	1297lm	1168lm	1-10V
						50°	1297lm	1234lm	DALI
	15W	36V	350mA	90	3000K	18°	1348lm	979lm	ON-OFF
						24°	1348lm	1195lm	TRIAC
						36°	1348lm	1217lm	1-10V
						50°	1348lm	1286lm	DALI
	15W	36V	350mA	90	4000K	18°	1411lm	1024lm	ON-OFF
						24°	1411lm	1250lm	TRIAC
						36°	1411lm	1273lm	1-10V
						50°	1411lm	1346lm	DALI

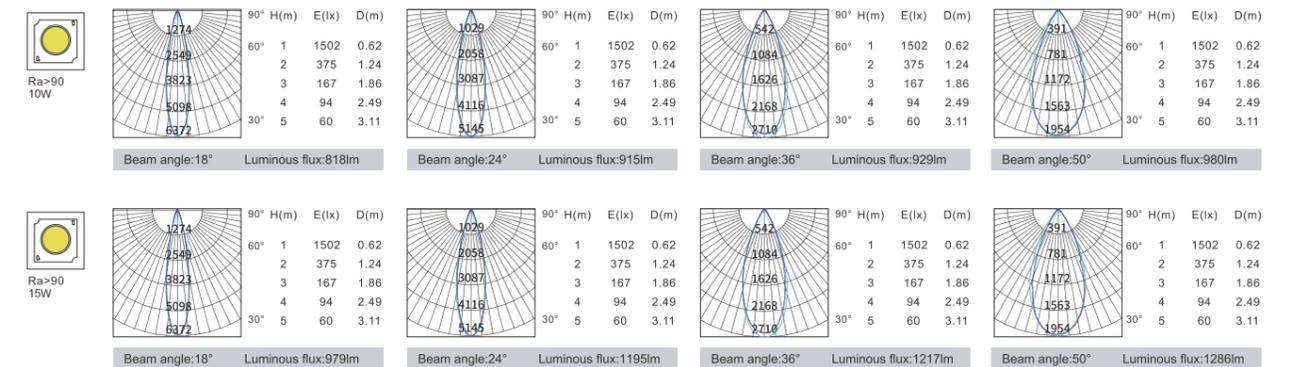

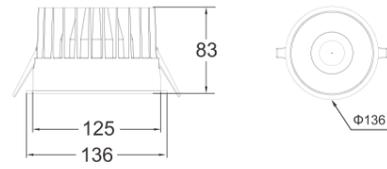
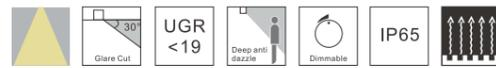

⌀ 125

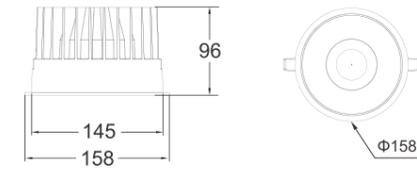
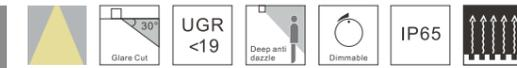

⌀ 145

Model	Power	LED voltage	LED Current	CRI	CCT	Beam Angle	LED Output	System output	Dimming Type
KAS-DL07P-R-415	15W	36V	350mA	90	2700K	18°	1556lm	1098lm	ON-OFF
						24°	1556lm	1292lm	TRIAC
						36°	1556lm	1347lm	1-10V
						55°	1556lm	1349lm	DALI
	15W	36V	350mA	90	3000K	18°	1611lm	1142lm	ON-OFF
						24°	1611lm	1343lm	TRIAC
						36°	1611lm	1400lm	1-10V
						55°	1611lm	1403lm	DALI
	15W	36V	350mA	90	4000K	18°	1692lm	1195lm	ON-OFF
						24°	1692lm	1405lm	TRIAC
						36°	1692lm	1465lm	1-10V
						55°	1692lm	1368lm	DALI
KAS-DL07P-R-420	20W	36V	500mA	90	2700K	18°	2224lm	1785lm	ON-OFF
						24°	2224lm	1796lm	TRIAC
						36°	2224lm	1854lm	1-10V
						55°	2224lm	1870lm	DALI
	20W	36V	500mA	90	3000K	18°	2311lm	1855lm	ON-OFF
						24°	2311lm	1866lm	TRIAC
						36°	2311lm	1927lm	1-10V
						55°	2311lm	1943lm	DALI
	20W	36V	500mA	90	4000K	18°	2415lm	1941lm	ON-OFF
						24°	2415lm	1953lm	TRIAC
						36°	2415lm	2017lm	1-10V
						55°	2415lm	2033lm	DALI

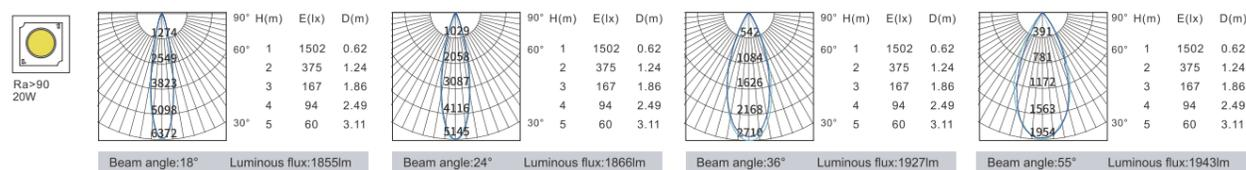

Model	Power	LED voltage	LED Current	CRI	CCT	Beam Angle	LED Output	System output	Dimming Type
KAS-DL07P-R-525	25W	36V	600mA	90	2700K	18°	2892lm	1908lm	ON-OFF
						24°	2892lm	2293lm	TRIAC
						36°	2892lm	2185lm	1-10V
						60°	2892lm	2220lm	DALI
	25W	36V	600mA	90	3000K	18°	3004lm	1982lm	ON-OFF
						24°	3004lm	2382lm	TRIAC
						36°	3004lm	2270lm	1-10V
						60°	3004lm	2306lm	DALI
	25W	36V	600mA	90	4000K	18°	3144lm	2074lm	ON-OFF
						24°	3144lm	2493lm	TRIAC
						36°	3144lm	2376lm	1-10V
						60°	3144lm	2413lm	DALI
KAS-DL07P-R-530	30W	36V	700mA	90	2700K	18°	3373lm	2279lm	ON-OFF
						24°	3373lm	2612lm	TRIAC
						36°	3373lm	2472lm	1-10V
						60°	3373lm	2523lm	DALI
	30W	36V	700mA	90	3000K	18°	3504lm	2368lm	ON-OFF
						24°	3504lm	2714lm	TRIAC
						36°	3504lm	2569lm	1-10V
						60°	3504lm	2622lm	DALI
	30W	36V	700mA	90	4000K	18°	3668lm	2478lm	ON-OFF
						24°	3668lm	2840lm	TRIAC
						36°	3668lm	2689lm	1-10V
						60°	3668lm	2744lm	DALI

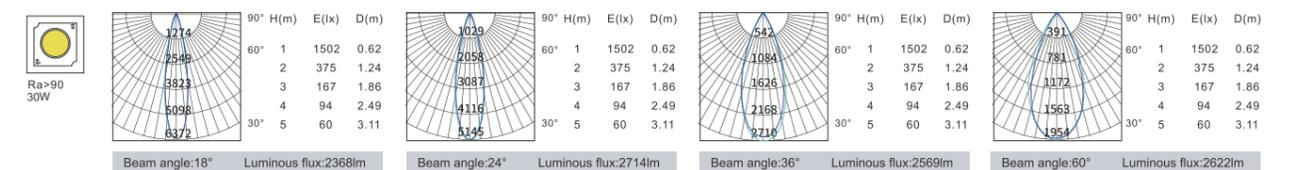
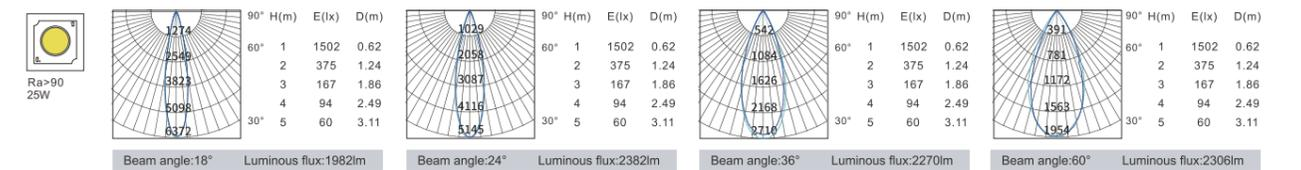

DL07P-R Series

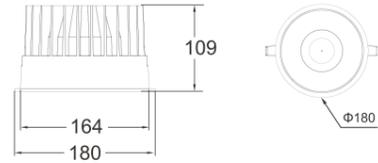
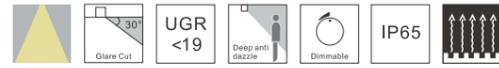

165

Model	Power	LED voltage	LED Current	CRI	CCT	Beam Angle	LED Output	System output	Dimming Type
KAS-DL07P-R-630	30W	36V	700mA	90	2700K	18°	3373lm	2096lm	ON-OFF
						24°	3373lm	2475lm	TRIAC
						36°	3373lm	2645lm	1-10V
						60°	3373lm	2506lm	DALI
	30W	36V	700mA	90	3000K	18°	3504lm	2178lm	ON-OFF
						24°	3504lm	2572lm	TRIAC
						36°	3504lm	2748lm	1-10V
						60°	3504lm	2604lm	DALI
	30W	36V	700mA	90	4000K	18°	3668lm	2279lm	ON-OFF
						24°	3668lm	2692lm	TRIAC
						36°	3668lm	2876lm	1-10V
						60°	3668lm	2725lm	DALI
KAS-DL07P-R-640	40W	36V	1000mA	90	2700K	18°	3708lm	2790lm	ON-OFF
						24°	3708lm	3305lm	TRIAC
						36°	3708lm	3542lm	1-10V
						60°	3708lm	3344lm	DALI
	40W	36V	1000mA	90	3000K	18°	3852lm	2899lm	ON-OFF
						24°	3852lm	3434lm	TRIAC
						36°	3852lm	3680lm	1-10V
						60°	3852lm	3474lm	DALI
	40W	36V	1000mA	90	4000K	18°	4032lm	3034lm	ON-OFF
						24°	4032lm	3594lm	TRIAC
						36°	4032lm	3851lm	1-10V
						60°	4032lm	3636lm	DALI

