

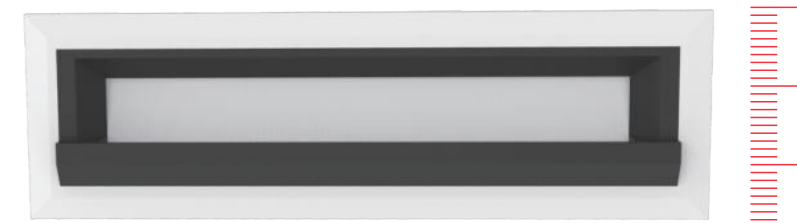

Satli Series  
Wall Washer



49mm

- Cree chip, Ra>90, no uv radiation, little heat emission.
- Professional aluminum reflector, can effectively block back scattering light for secondary reflection, reducing the loss of light efficiency.
- It adopts passive heat dissipation technology and is equipped with highly efficient wave-shaped radiator, which can carry out air convection heat dissipation before and after, increase the area of heat exchange surface, and the heat dissipation area is more than 10% higher than that of ordinary radiator.
- Deep shading Angle, see the light but not the lamp.

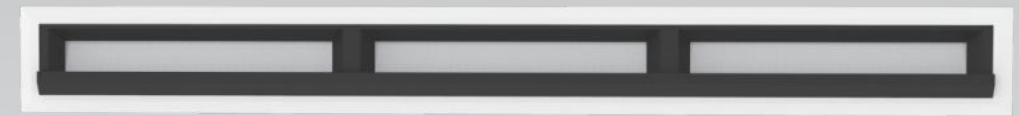
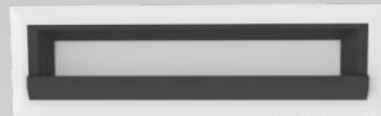
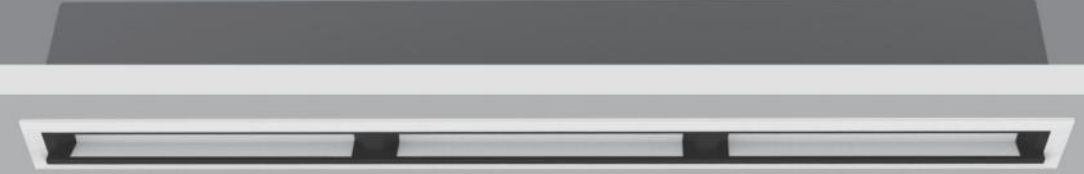
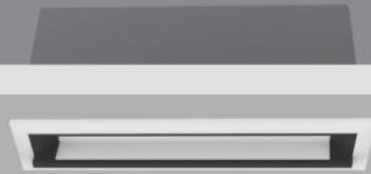

KS-BL01R-1W-14  
Power: 10W  
Cutout: 140\*37mm  
Height: 49mm

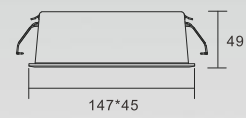

KS-BL01R-2W-28  
Power: 20W  
Cutout: 273\*37mm  
Height: 49mm

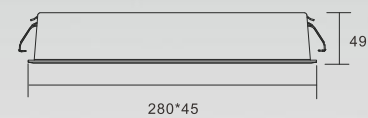

KS-BL01R-3W-42  
Power: 30W  
Cutout: 412.7\*45mm  
Height: 49mm

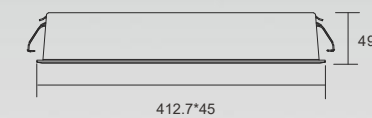

Model	KS-BL01R-1W-14	KS-BL01R-2W-28	KS-BL01R-3W-42
Product Photo			
Dimension(mm)			
Cutout(mm)	140*37	273*37	405*37
Wattage	10W	20W	30W
CCT	2700K 3000K 3500K 4000K 5000K	2700K 3000K 3500K 4000K 5000K	2700K 3000K 3500K 4000K 5000K
CRI	>90	>90	>90
Beam Angle	Wall washer	Wall washer	Wall washer
Lumen	395-463LM	665-782LM	1054-1243LM
IP	IP 20	IP 20	IP 20
Dimming	TRIAC/1-10V/DALI	TRIAC/1-10V/DALI	TRIAC/1-10V/DALI
Colour	White+Iron gray	White+Iron gray	White+Iron gray

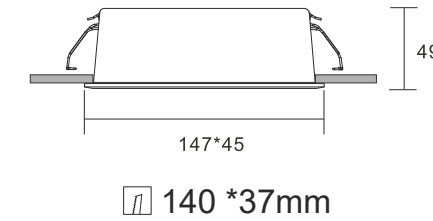
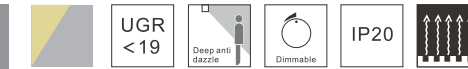

Model	Power	LED voltage	LED Current	CRI	CCT	Beam Angle	LED Output	System output	Dimming Type
KS-BL01R-1W-1410	10W	15V	600mA	90	2700K	Wall washer	696lm	395lm	ON-OFF TRIAC 1-10V DALI
	10W	15V	600mA	90	3000K	Wall washer	752lm	427lm	ON-OFF TRIAC 1-10V DALI
	10W	15V	600mA	90	4000K	Wall washer	816lm	463lm	ON-OFF TRIAC 1-10V DALI

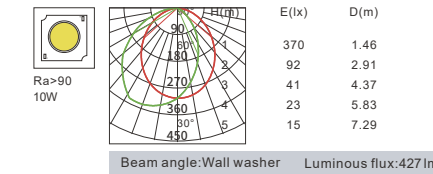

Satli Series  
Wall Washer

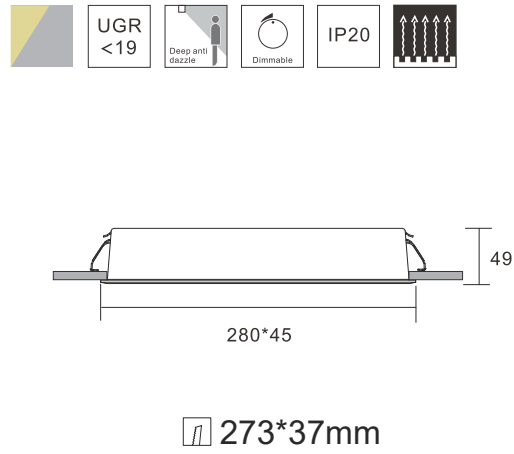

Model	Power	LED voltage	LED Current	CRI	CCT	Beam Angle	LED Output	System output	Dimming Type
KS-BL01R-2W-2820	20W	30V	600mA	90	2700K	Wall washer	1156lm	665lm	ON-OFF TRIAC 1-10V DALI
	20W	30V	600mA	90	3000K	Wall washer	1251lm	720lm	ON-OFF TRIAC 1-10V DALI
	20W	30V	600mA	90	4000K	Wall washer	1360lm	782lm	ON-OFF TRIAC 1-10V DALI

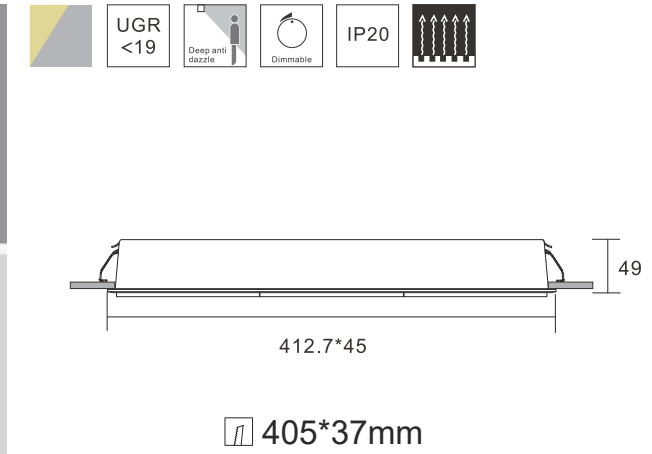
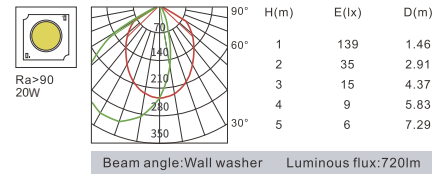

Model	Power	LED voltage	LED Current	CRI	CCT	Beam Angle	LED Output	System output	Dimming Type
KS-BL01R-3W-4230	30W	36V	600mA	90	2700K	Wall washer	1534lm	1054lm	ON-OFF TRIAC 1-10V DALI
	30W	36V	600mA	90	3000K	Wall washer	1662lm	1143lm	ON-OFF TRIAC 1-10V DALI
	30W	36V	600mA	90	4000K	Wall washer	1808lm	1243lm	ON-OFF TRIAC 1-10V DALI

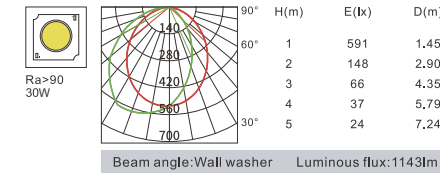

Installation Distance

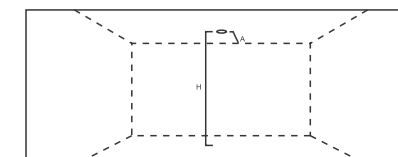

Model: 10W A:800mm H:3000mm

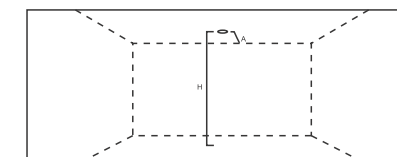

Model: 20W A:1000mm H:3000mm

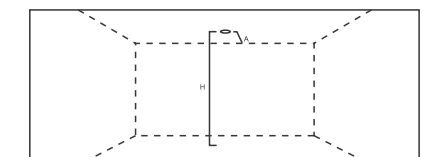

Model: 30W A:1000mm H:3000mm

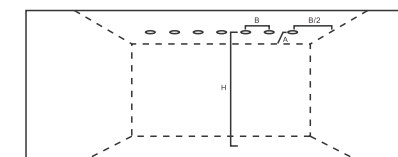

Model: 10W A:800mm B:800mm H:3000mm

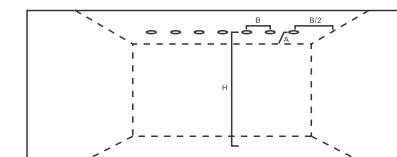

Model: 20W A:1000mm B:800mm H:3000mm

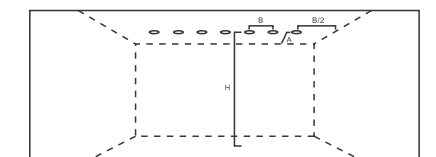

Model: 30W A:1000mm B:1000mm H:3000mm