

Underground Lamp

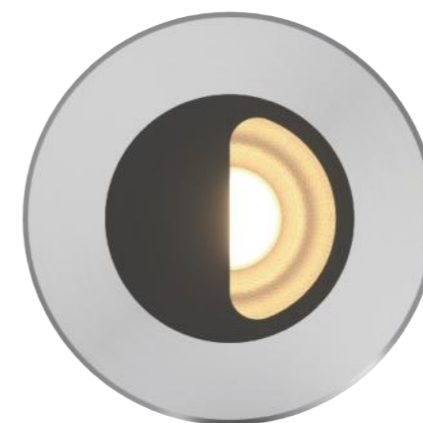

- Stainless steel lamp body material, anti-rust and anti-corrosion, with good heat dissipation effect.
- Embedded parts installation structure, installation and debugging more convenient.
- IP67 protection level, to achieve moisture and fog.
- The use of high quality tempered glass mask, hardness, seismic not easily broken.



VT-UDL003-35-Y3W-A
Power: 1W/3W
Cutout: 30mm
Height: 41mm/58mm

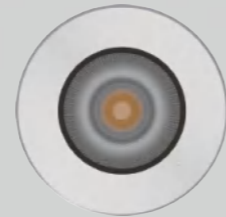

KAS-BU02
Power: 3W/7W/9W
Cutout: 55/65
Height: 76.5/85mm

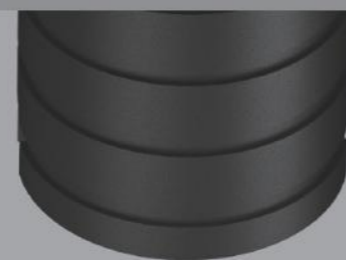
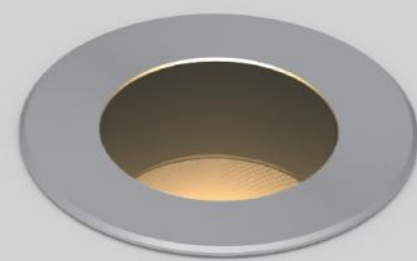
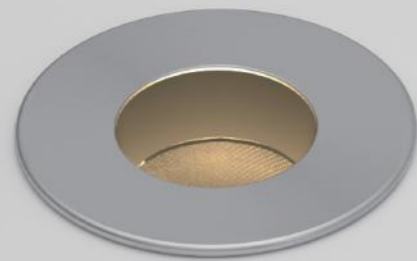
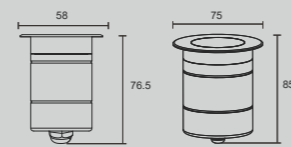
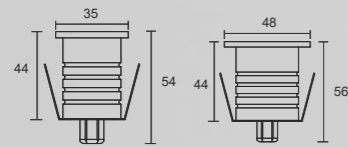

Model	VT-UDL003-35-Y3W-A	KAS-BU02	KAS-BS02	KAS-BS03
Product Photo				
Dimension(mm)				
Cutout(mm)	35-40	55-65		
Wattage	1W/3W	3W/5W/7W	3W/7W	3W/7W
CCT	2700K 3000K 4000K 4500K 6000K 6500K	2700K 3000K 4000K 4500K	2700K 3000K 4000K 4500K	2700K 3000K 4000K 4500K
CRI	>80	>80	>80	>80
Beam Angle	15°/30°	10°/15°/24°/36°/55°	10°/15°/24°/36°/55°	10°/15°/24°/36°/55°
Lumen	84-75lm	326-333lm	326-333lm	326-333lm
IP	IP 67	IP 67	IP 67	IP 67
Accessory		Honeycomb Filter	Honeycomb Filter	Honeycomb Filter
Colour	Stainless Steel+Black	Stainless Steel+Black	Stainless Steel+Black	Stainless Steel+Black

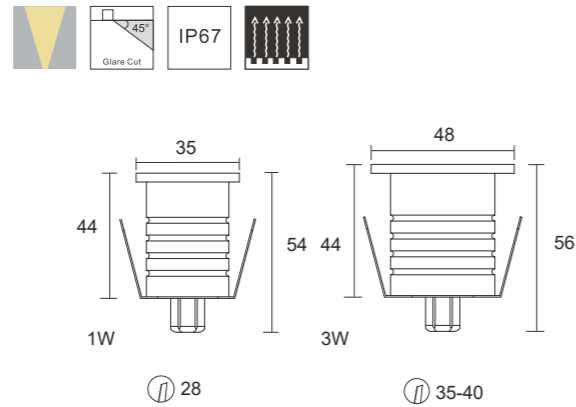

Model	Power	LED voltage	LED Current	CRI	CCT	Beam Angle	LED Output	System output	Dimming Type
VT-UDL003-35-1W-C	1W	3V	200mA	90	2700K	15°	90lm	39lm	ON-OFF
						30°	90lm	42lm	TRIAC
						45°	90lm	48lm	1-10V
						120°	90lm	56lm	DALI
	1W	3V	200mA	90	3000K	15°	97lm	43lm	ON-OFF
						30°	97lm	46lm	TRIAC
						45°	97lm	52lm	1-10V
						120°	97lm	61lm	DALI
	1W	3V	200mA	90	4000K	15°	105lm	46lm	ON-OFF
						30°	105lm	49lm	TRIAC
						45°	105lm	56lm	1-10V
						120°	105lm	66lm	DALI
VT-UDL003-35-3W-C	3W	6V	400mA	90	2700K	15°	198lm	78lm	ON-OFF
						30°	198lm	69lm	TRIAC
						45°	198lm	72lm	1-10V
						120°	198lm	74lm	DALI
	3W	6V	400mA	90	3000K	15°	213lm	87lm	ON-OFF
						30°	213lm	75lm	TRIAC
						45°	213lm	78lm	1-10V
						120°	213lm	80lm	DALI
	3W	6V	400mA	90	4000K	15°	231lm	97lm	ON-OFF
						30°	231lm	81lm	TRIAC
						45°	231lm	84lm	1-10V
						120°	231lm	86lm	DALI

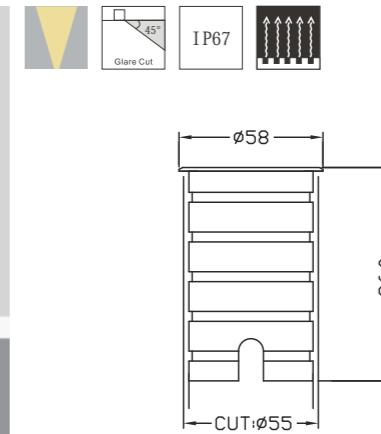
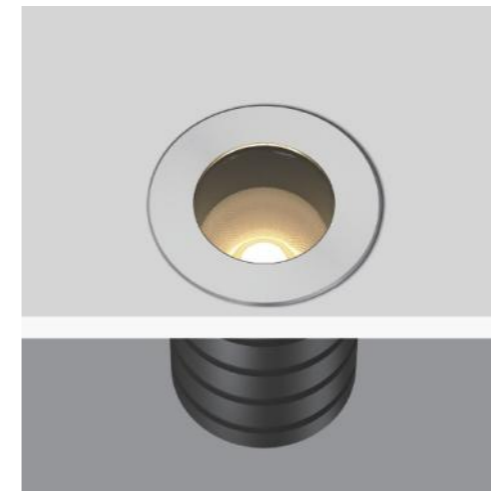
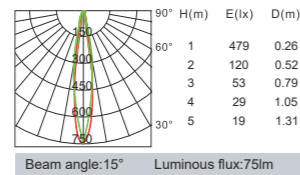
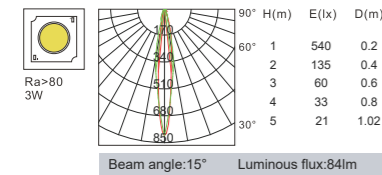

Model	Power	LED voltage	LED Current	CRI	CCT	Beam Angle	LED Output	System output	Dimming Type
KAS-BU02-03-1D	3W	9V	300mA	90	2700K	15°	338lm	315lm	ON-OFF
						24°	338lm	331lm	TRIAC
						36°	338lm	345lm	1-10V
									DALI
	3W	9V	300mA	90	3000K	15°	350lm	326lm	ON-OFF
						24°	350lm	343lm	TRIAC
						36°	350lm	357lm	1-10V
									DALI
	3W	9V	300mA	90	4000K	15°	415lm	387lm	ON-OFF
						24°	415lm	407lm	TRIAC
						36°	415lm	423lm	1-10V
									DALI
KAS-BU02-05-1D	5W	9V	450mA	90	2700K	10°	525lm	241lm	ON-OFF
						15°	525lm	298lm	ON-OFF
						24°	525lm	313lm	TRIAC
						36°	525lm	326lm	1-10V
	5W	9V	450mA	90	3000K	10°	575lm	264lm	ON-OFF
						15°	575lm	326lm	ON-OFF
						24°	575lm	343lm	TRIAC
						36°	575lm	357lm	1-10V
	5W	9V	450mA	90	4000K	10°	575lm	333lm	DALI
						15°	586lm	269lm	ON-OFF
						24°	586lm	332lm	ON-OFF
						36°	586lm	350lm	TRIAC
5W	9V	450mA	90	4000K	36°	586lm	364lm	1-10V	
					55°	586lm	339lm	DALI	

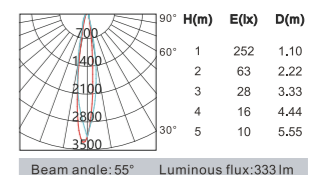
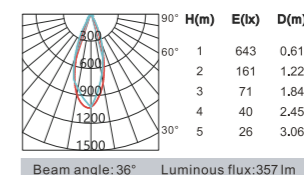
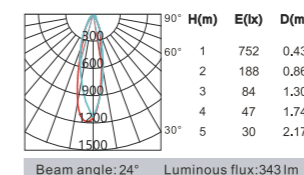
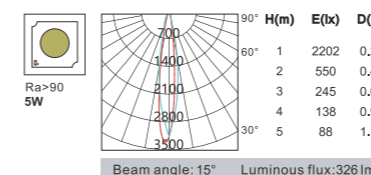
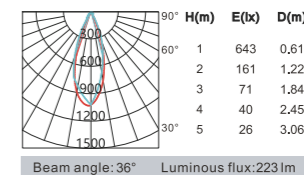
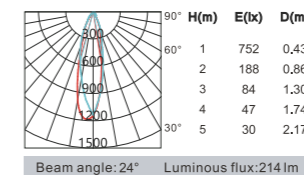
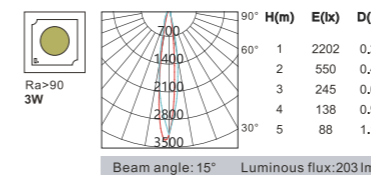

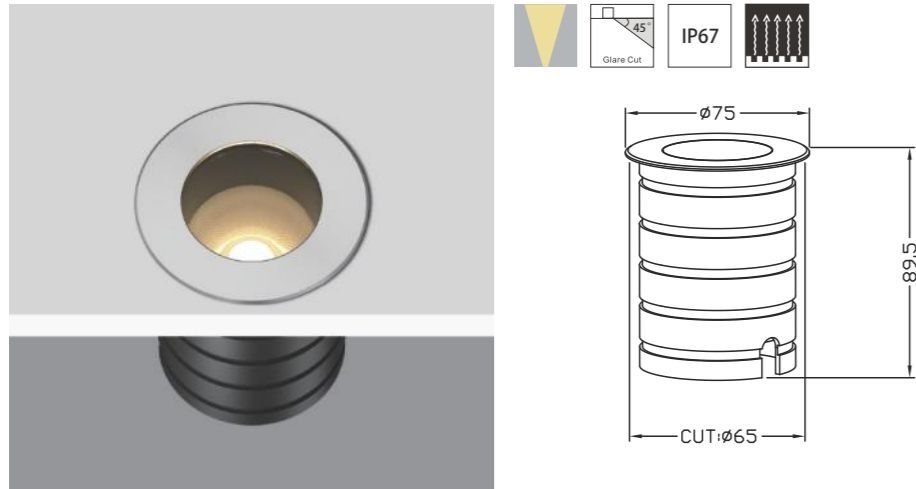

Model	Power	LED voltage	LED Current	CRI	CCT	Beam Angle	LED Output	System output	Dimming Type
KAS-BU03-05-1D	5W	9V	450mA	90	2700K	10°	525lm	243lm	ON-OFF TRIAC 1-10V DALI
						15°	525lm	394lm	
						24°	525lm	390lm	
						36°	525lm	403lm	
						55°	525lm	382lm	
	5W	9V	450mA	90	3000K	10°	575lm	264lm	ON-OFF TRIAC 1-10V DALI
						15°	575lm	428lm	
						24°	575lm	423lm	
						36°	575lm	437lm	
						55°	575lm	415lm	
	5W	9V	450mA	90	4000K	10°	586lm	271lm	ON-OFF TRIAC 1-10V DALI
						15°	586lm	440lm	
						24°	586lm	435lm	
						36°	586lm	449lm	
						55°	586lm	427lm	
KAS-BU03-07-1D	7W	9V	700mA	90	2700K	10°	693lm	371lm	ON-OFF TRIAC 1-10V DALI
						15°	693lm	406lm	
						24°	693lm	402lm	
						36°	693lm	415lm	
						55°	693lm	394lm	
	7W	9V	700mA	90	3000K	10°	730lm	344lm	ON-OFF TRIAC 1-10V DALI
						15°	730lm	428lm	
						24°	730lm	423lm	
						36°	730lm	437lm	
						55°	730lm	415lm	
	7W	9V	700mA	90	4000K	10°	798lm	376lm	ON-OFF TRIAC 1-10V DALI
						15°	798lm	468lm	
						24°	798lm	462lm	
						36°	798lm	437lm	
						55°	798lm	478lm	

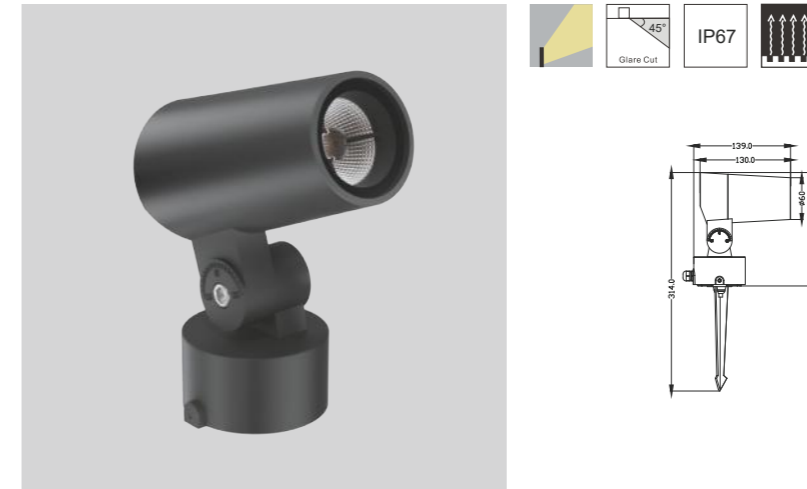
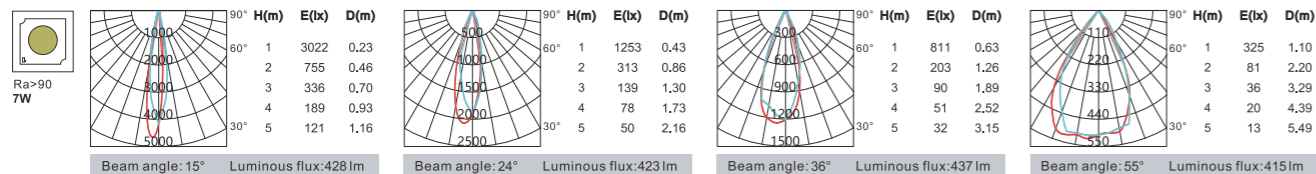

Model	Power	LED voltage	LED Current	CRI	CCT	Beam Angle	LED Output	System output	Dimming Type
KAS-BS04-03-3D	3W	9V	300mA	90	2700K	15°	338lm	316lm	ON-OFF TRIAC 1-10V DALI
						24°	338lm	327lm	
						36°	338lm	344lm	
	3W	9V	300mA	90	3000K	15°	350lm	327lm	ON-OFF TRIAC 1-10V DALI
						24°	350lm	339lm	
						36°	350lm	356lm	
3W	9V	300mA	90	4000K	15°	415lm	388lm	ON-OFF TRIAC 1-10V DALI	
					24°	415lm	402lm		
					36°	415lm	422lm		
KAS-BS04-05-3D	5W	9V	450mA	90	2700K	15°	525lm	301lm	ON-OFF TRIAC 1-10V DALI
						24°	525lm	312lm	
						36°	525lm	328lm	
	5W	9V	450mA	90	3000K	15°	575lm	327lm	ON-OFF TRIAC 1-10V DALI
						24°	575lm	339lm	
						36°	575lm	356lm	
5W	9V	450mA	90	4000K	15°	586lm	336lm	ON-OFF TRIAC 1-10V DALI	
					24°	586lm	349lm		
					36°	586lm	366lm		

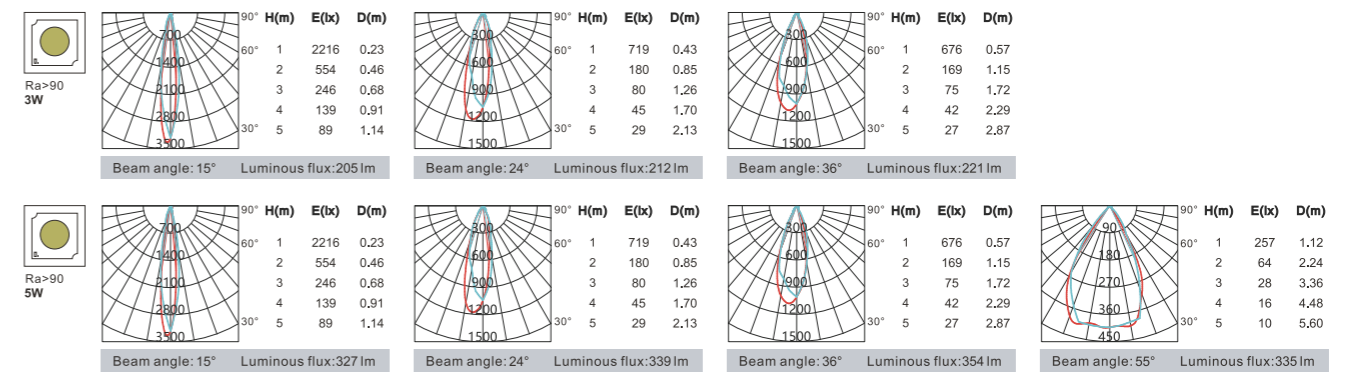

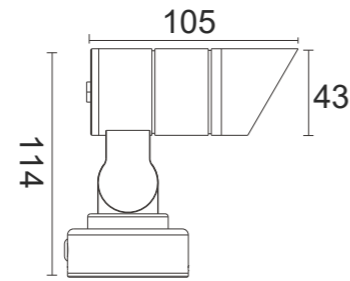
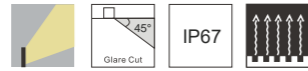

Model	Power	LED voltage	LED Current	CRI	CCT	Beam Angle	LED Output	System output	Dimming Type
KAS-BS03-05-2D	3W	9V	300mA	90	2700K	15°	338lm	316lm	ON-OFF
						24°	338lm	327lm	TRIAC
						36°	338lm	344lm	1-10V
	3W	9V	300mA	90	3000K	15°	350lm	327lm	DALI
						24°	350lm	339lm	ON-OFF
						36°	350lm	356lm	TRIAC
	3W	9V	300mA	90	4000K	15°	415lm	388lm	1-10V
						24°	415lm	402lm	DALI
						36°	415lm	422lm	ON-OFF

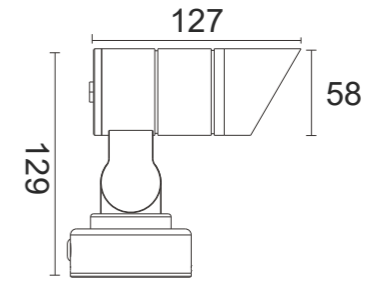
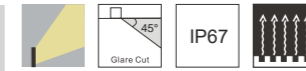
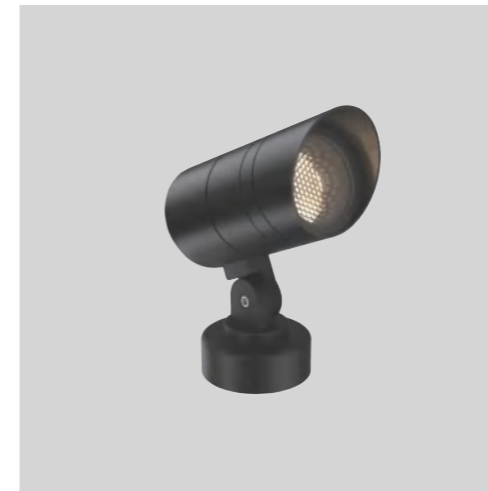
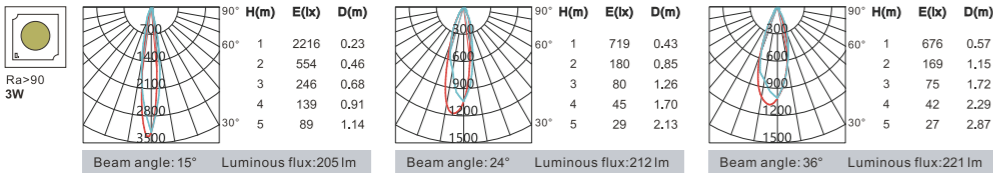

Model	Power	LED voltage	LED Current	CRI	CCT	Beam Angle	LED Output	System output	Dimming Type
KAS-BS03-07-2D	7W	9V	700mA	90	2700K	10°	693lm	371lm	ON-OFF
						15°	693lm	406lm	TRIAC
						24°	693lm	402lm	1-10V
						36°	693lm	415lm	DALI
						55°	693lm	394lm	
						10°	730lm	344lm	ON-OFF
	7W	9V	700mA	90	3000K	15°	730lm	428lm	TRIAC
						24°	730lm	423lm	1-10V
						36°	730lm	437lm	DALI
						55°	730lm	415lm	
						10°	798lm	376lm	ON-OFF
						15°	798lm	468lm	TRIAC
7W	9V	700mA	90	4000K	24°	798lm	462lm	1-10V	
					36°	798lm	437lm	DALI	
					55°	798lm	478lm		
					10°	798lm	468lm	ON-OFF	
					15°	798lm	462lm	TRIAC	
					24°	798lm	437lm	1-10V	

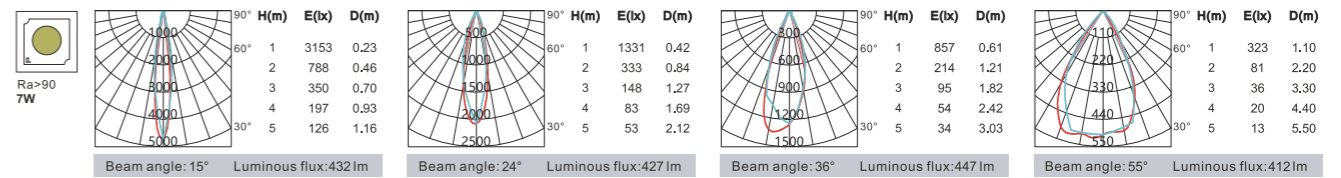

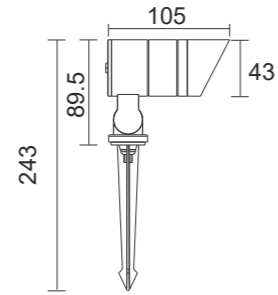
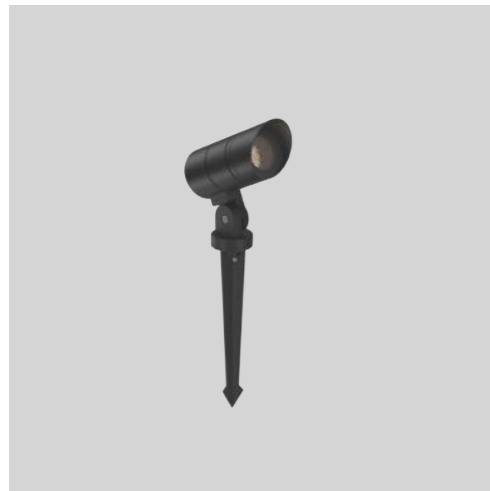

Model	Power	LED voltage	LED Current	CRI	CCT	Beam Angle	LED Output	System output	Dimming Type
KAS-BS03-05-3D	3W	9V	300mA	90	2700K	15°	338lm	316lm	ON-OFF
						24°	338lm	327lm	TRIAC
						36°	338lm	344lm	1-10V
	3W	9V	300mA	90	3000K	15°	350lm	327lm	ON-OFF
						24°	350lm	339lm	TRIAC
						36°	350lm	356lm	1-10V
	3W	9V	300mA	90	4000K	15°	415lm	388lm	ON-OFF
						24°	415lm	402lm	TRIAC
						36°	415lm	422lm	1-10V
									DALI

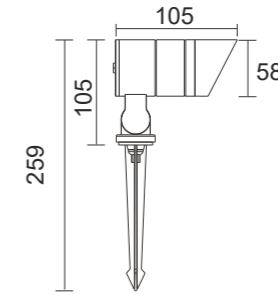
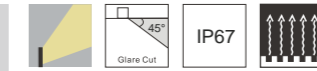
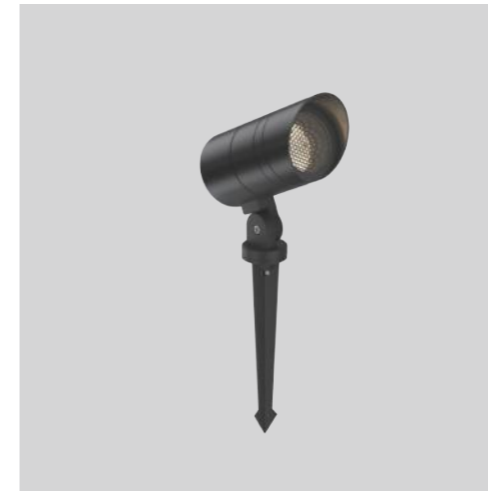
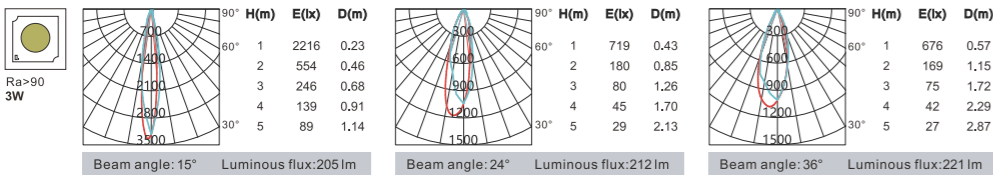

Model	Power	LED voltage	LED Current	CRI	CCT	Beam Angle	LED Output	System output	Dimming Type
KAS-BS03-07-3D	7W	9V	700mA	90	2700K	10°	693lm	371lm	ON-OFF
						15°	693lm	406lm	TRIAC
						24°	693lm	402lm	1-10V
						36°	693lm	415lm	DALI
						55°	693lm	394lm	
						10°	730lm	344lm	ON-OFF
	7W	9V	700mA	90	3000K	15°	730lm	428lm	ON-OFF
						24°	730lm	423lm	TRIAC
						36°	730lm	437lm	1-10V
						55°	730lm	415lm	DALI
						10°	798lm	376lm	ON-OFF
						15°	798lm	468lm	ON-OFF
7W	9V	700mA	90	4000K	24°	798lm	462lm	TRIAC	
					36°	798lm	437lm	1-10V	
					55°	798lm	478lm	DALI	
					10°	798lm	468lm	ON-OFF	
					15°	798lm	462lm	TRIAC	
					24°	798lm	462lm	1-10V	

