

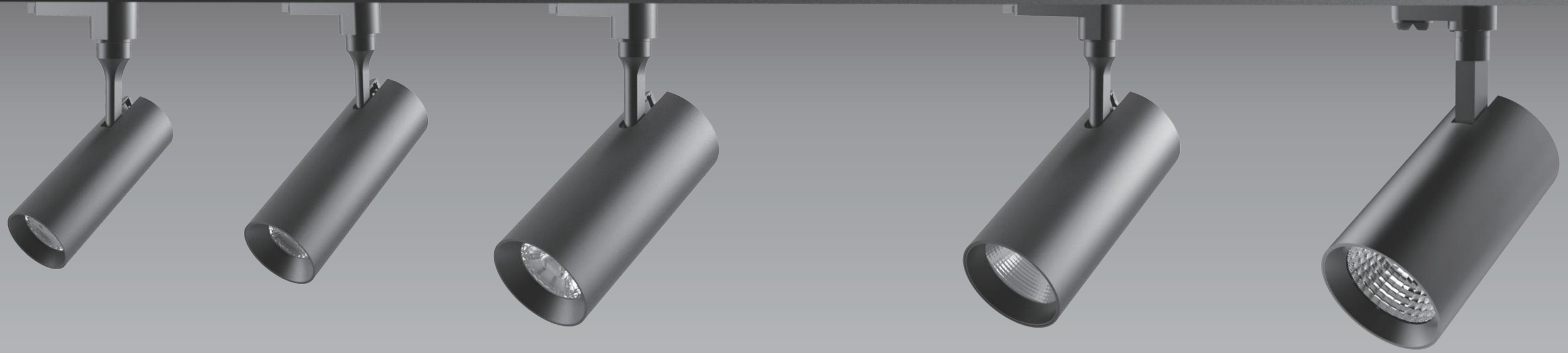

Being elegant in appearance with built-in driver design its optical performance is outstanding. Mechanical performance is good with 350° rotation and 90° tilt to adjust light direction flexibly.



- Top brand high lumen COB LED, luminous efficiency of the whole lighting fixture can be above 85lm/w.
- Horizontal rotation 350° and vertical tilt 90°, achieving precise spotting angle.
- Anti-glare designed lamp body.
- Use high quality die-casting aluminium heat sink with convection cooling method, cooling fast to low down luminous decay efficiently.
- Same light with track, recessed, and mounted installation method.



KAS-TL10L-A-50
Power: 7W
Diameter: 50mm

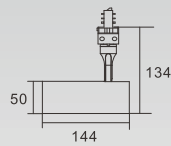

KAS-TL10L-A-66
Power: 10W/15W
Diameter: 66mm

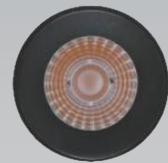
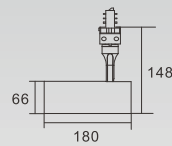

KAS-TL10L-A-80
Power: 25W/30W
Diameter: 80mm

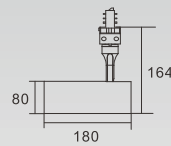

KAS-TL10R-A-80
Power: 25W/30W
Diameter: 80mm

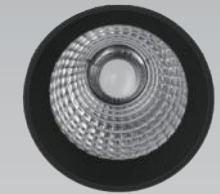
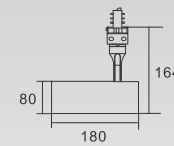

KAS-TL10R-A-93
Power: 25W/30W
Diameter: 93mm

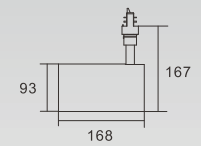

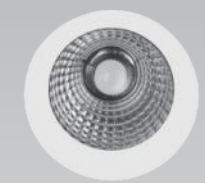
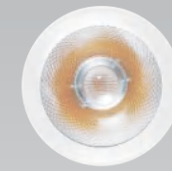
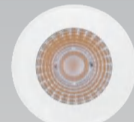

KAS-TL10L-A-50
Power: 7W
Diameter: 50mm

KAS-TL10L-A-66
Power: 10W/15W
Diameter: 66mm

KAS-TL10L-A-80
Power: 25W/30W
Diameter: 80mm

KAS-TL10R-A-80
Power: 25W/30W
Diameter: 80mm

KAS-TL10R-A-93
Power: 25W/30W
Diameter: 93mm

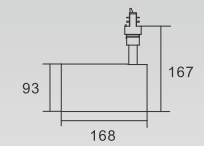
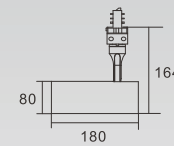
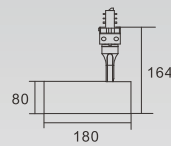
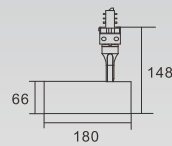
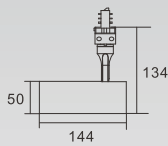

TL 10 Series
Top-mounted Spotlight

Model	KAS-TL10L-A-50	KAS-TL10L-A-66	KAS-TL10L-A-80	KAS-TL10R-A-80	KAS-TL10R-A-93
Product Photo					
Dimension(mm)					
Wattage	7W	10W/15W	25W/30W	25W/30W	25W/30W
CCT	3000K/3500K/4000K	3000K/3500K/4000K	3000K/3500K/4000K	3000K/3500K/4000K	3000K/3500K/4000K
CRI	>90	>90	>90	>90	>90
Beam Angle	10°/15°/20°/30°	10°/15°/20°/36°	10°/15°/20°/36°	20°/24°/30°/36°	15°/20°/36°/60°
Lumen	385LM	800-1125LM	2125-2400LM	2000-2250LM	2125-2550LM
IP	IP 20	IP 20	IP 20	IP 20	IP 20
Dimming		TRIAC	TRIAC/1-10V/DALI	TRIAC/1-10V/DALI	TRIAC/1-10V/DALI
Accessory	Honeycomb Filter Stripped Glass Fabric Glass	Honeycomb Filter Stripped Glass Fabric Glass	Honeycomb Filter Stripped Glass Fabric Glass	Honeycomb Filter Stripped Glass Fabric Glass	
Installation	1-phase track 2-phase track 3-phase track	1-phase track 2-phase track 3-phase track	1-phase track 2-phase track 3-phase track	1-phase track 2-phase track 3-phase track	1-phase track 2-phase track 3-phase track
Colour	Black/White	Black/White	Black/White	Black/White	Black/White

Optical Accessories



Honeycomb Filter Stripped Glass Fabric Glass

TL 10 Series
Top-mounted Spotlight

Model	KAS-TL10L-A-50	KAS-TL10L-A-66	KAS-TL10L-A-80	KAS-TL10R-A-80	KAS-TL10R-A-93
Product Photo					
Dimension(mm)					
Wattage	7W	10W/15W	25W/30W	25W/30W	25W/30W
CCT	3000K/3500K/4000K	3000K/3500K/4000K	3000K/3500K/4000K	3000K/3500K/4000K	3000K/3500K/4000K
CRI	>90	>90	>90	>90	>90
Beam Angle	10°/15°/20°/30°	10°/15°/20°/36°	10°/15°/20°/36°	20°/24°/30°/36°	15°/20°/36°/60°
Lumen	385LM	800-1125LM	2125-2400LM	2000-2250LM	2125-2550LM
IP	IP 20	IP 20	IP 20	IP 20	IP 20
Dimming		TRIAC	TRIAC/1-10V/DALI	TRIAC/1-10V/DALI	TRIAC/1-10V/DALI
Accessory	Honeycomb Filter Stripped Glass Fabric Glass	Honeycomb Filter Stripped Glass Fabric Glass	Honeycomb Filter Stripped Glass Fabric Glass	Honeycomb Filter Stripped Glass Fabric Glass	Honeycomb Filter Stripped Glass Fabric Glass
Installation	1-phase track 2-phase track 3-phase track	1-phase track 2-phase track 3-phase track	1-phase track 2-phase track 3-phase track	1-phase track 2-phase track 3-phase track	1-phase track 2-phase track 3-phase track
Colour	Black/White	Black/White	Black/White	Black/White	Black/White

Optical Accessories



Honeycomb Filter Stripped Glass Fabric Glass

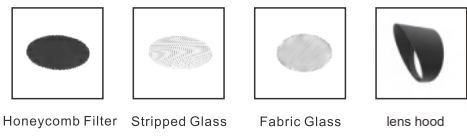
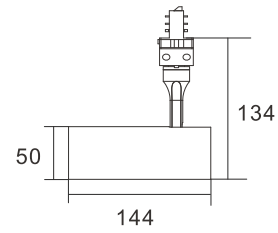
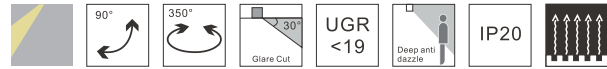

Model	Power	LED voltage	LED Current	CRI	CCT	Beam Angle	LED Output	System output	Dimming Type
KAS-TL10L-A-5007	7W	34V	150mA	90	2700K	10°	835lm	718lm	ON-OFF
						15°	835lm	743lm	
						20°	835lm	760lm	
						30°	835lm	725lm	
	7W	34V	150mA	90	3000K	10°	860lm	740lm	ON-OFF
						15°	860lm	766lm	
						20°	860lm	783lm	
						30°	860lm	747lm	
	7W	34V	150mA	90	4000K	10°	872lm	750lm	ON-OFF
						15°	872lm	776lm	
						20°	872lm	793lm	
						30°	872lm	757lm	

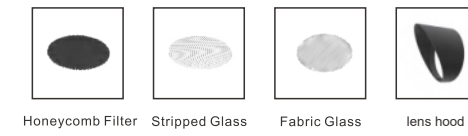
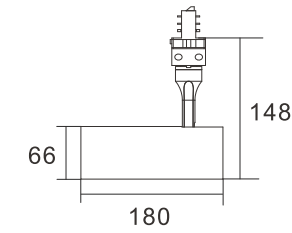
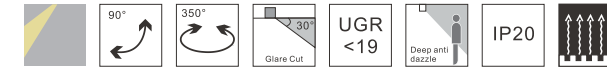
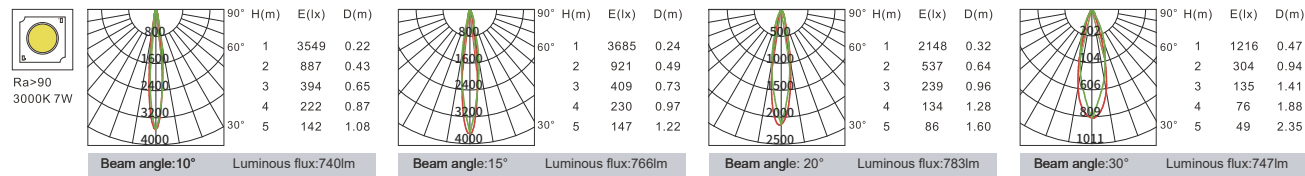

Model	Power	LED voltage	LED Current	CRI	CCT	Beam Angle	LED Output	System output	Dimming Type
KAS-TL10L-A-6610	10W	34V	250mA	90	2700K	10°	1058lm	761lm	ON-OFF
						15°	1058lm	806lm	
						20°	1058lm	717lm	
						36°	1058lm	790lm	
	10W	34V	250mA	90	3000K	10°	1099lm	791lm	ON-OFF
						15°	1099lm	837lm	
						20°	1099lm	745lm	
						36°	1099lm	821lm	
	10W	34V	250mA	90	4000K	10°	1118lm	804lm	ON-OFF
						15°	1118lm	851lm	
						20°	1118lm	757lm	
						36°	1118lm	835lm	
KAS-TL10L-A-6615	15W	34V	350mA	90	2700K	10°	1482lm	960lm	ON-OFF
						15°	1482lm	1031lm	
						20°	1482lm	918lm	
						36°	1482lm	1006lm	
	15W	34V	350mA	90	3000K	10°	1538lm	997lm	ON-OFF
						15°	1538lm	1070lm	
						20°	1538lm	953lm	
						36°	1538lm	1045lm	
	15W	34V	350mA	90	4000K	10°	1564lm	1013lm	ON-OFF
						15°	1564lm	1080lm	
						20°	1564lm	969lm	
						36°	1564lm	1062lm	

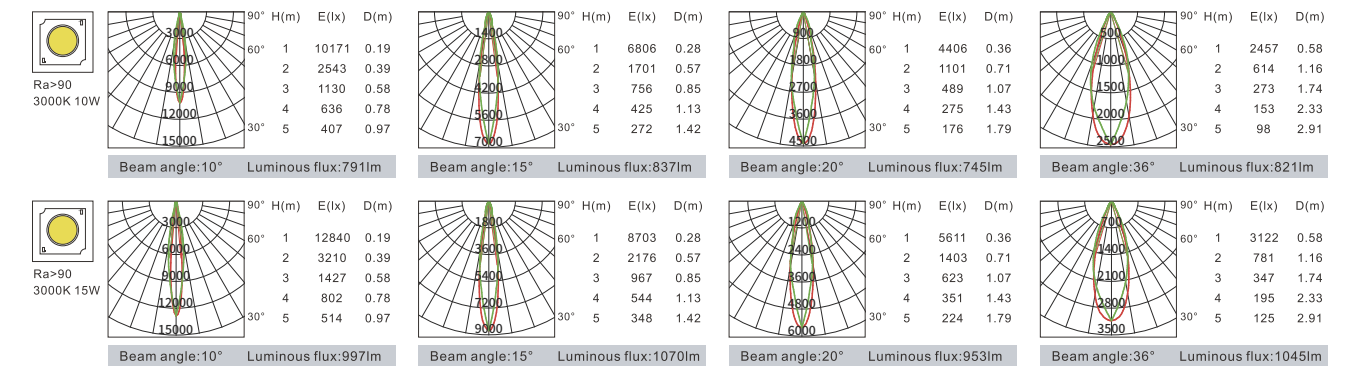

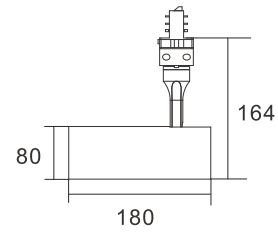
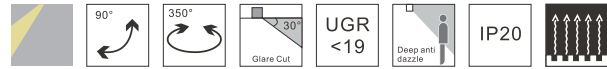

Model	Power	LED voltage	LED Current	CRI	CCT	Beam Angle	LED Output	System output	Dimming Type
KAS-TL10L-A-8025	25W	34V	600mA	90	2700K	10°	2446lm	1604lm	ON-OFF
						15°	2446lm	1948lm	TRIAC
						20°	2446lm	1809lm	1-10V
						36°	2446lm	1881lm	DALI
	25W	34V	600mA	90	3000K	10°	2545lm	1666lm	ON-OFF
						15°	2545lm	2027lm	TRIAC
						20°	2545lm	1883lm	1-10V
						36°	2545lm	1885lm	DALI
	25W	34V	600mA	90	4000K	10°	2586lm	1692lm	ON-OFF
						15°	2586lm	2059lm	TRIAC
						20°	2586lm	1913lm	1-10V
						36°	2586lm	1915lm	DALI
KAS-TL10L-A-8030	30W	34V	700mA	90	2700K	15°	2853lm	2164lm	ON-OFF
						20°	2853lm	2048lm	TRIAC
						36°	2853lm	2226lm	1-10V
									DALI
	30W	34V	700mA	90	3000K	15°	2970lm	2253lm	ON-OFF
						20°	2970lm	2133lm	TRIAC
						36°	2970lm	2138lm	1-10V
									DALI
	30W	34V	700mA	90	4000K	15°	3018lm	2289lm	ON-OFF
						20°	3018lm	2167lm	TRIAC
						36°	3018lm	2170lm	1-10V
									DALI

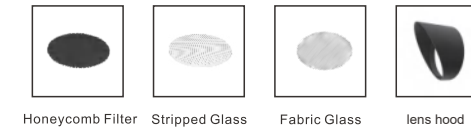
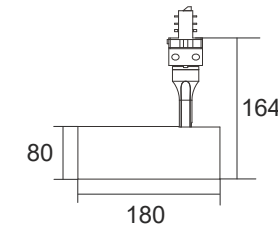
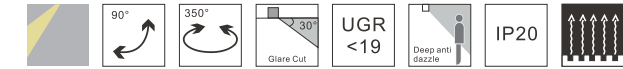
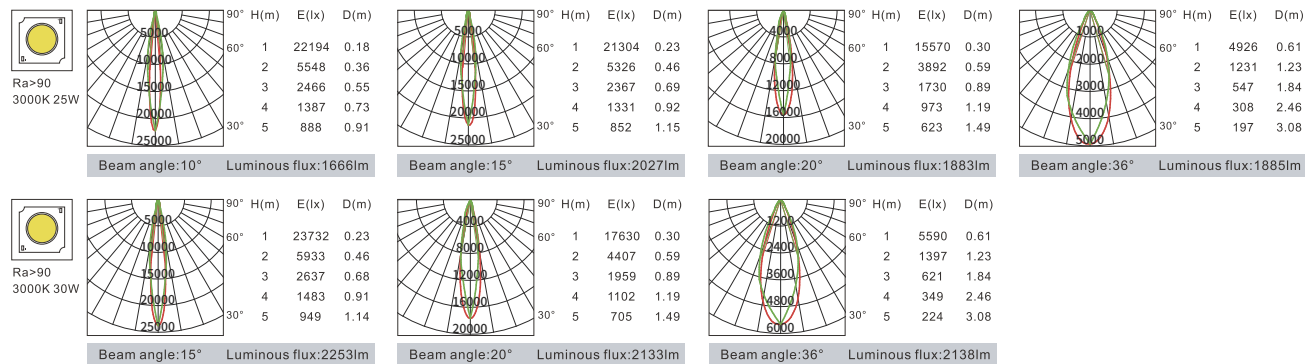

Model	Power	LED voltage	LED Current	CRI	CCT	Beam Angle	LED Output	System output	Dimming Type
KAS-TL10R-A-8025	25W	34V	600mA	90	2700K	20°	2446lm	1864lm	ON-OFF
						24°	2446lm	1840lm	TRIAC
						30°	2446lm	1801lm	1-10V
						36°	2446lm	1862lm	DALI
	25W	34V	600mA	90	3000K	20°	2545lm	1940lm	ON-OFF
						24°	2545lm	1915lm	TRIAC
						30°	2545lm	1874lm	1-10V
						36°	2545lm	1938lm	DALI
	25W	34V	600mA	90	4000K	20°	2586lm	1971lm	ON-OFF
						24°	2586lm	1945lm	TRIAC
						30°	2586lm	1904lm	1-10V
						36°	2586lm	1969lm	DALI
KAS-TL10R-A-8030	30W	34V	700mA	90	2700K	20°	2853lm	2115lm	ON-OFF
						24°	2853lm	2088lm	TRIAC
						30°	2853lm	2046lm	1-10V
						36°	2853lm	2084lm	DALI
	30W	34V	700mA	90	3000K	20°	2970lm	2202lm	ON-OFF
						24°	2970lm	2174lm	TRIAC
						30°	2970lm	2130lm	1-10V
						36°	2970lm	2170lm	DALI
	30W	34V	700mA	90	4000K	20°	3018lm	2237lm	ON-OFF
						24°	3018lm	2209lm	TRIAC
						30°	3018lm	2164lm	1-10V
						36°	3018lm	2205lm	DALI

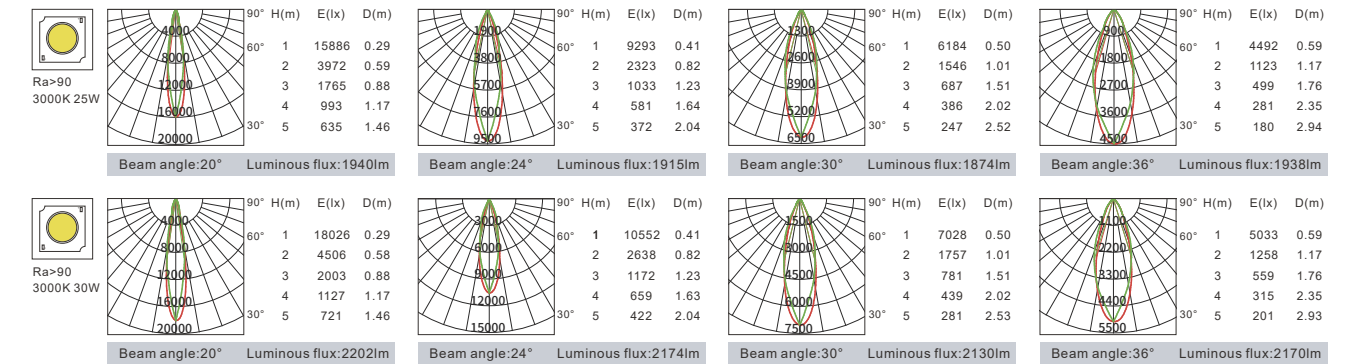

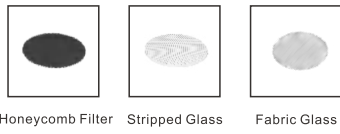
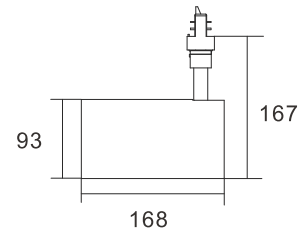

Honeycomb Filter Stripped Glass Fabric Glass

Model	Power	LED voltage	LED Current	CRI	CCT	Beam Angle	LED Output	System output	Dimming Type
KAS-TL10R-A-9325	25W	34V	600mA	90	2700K	15°	2446lm	2111lm	ON-OFF
						20°	2446lm	1905lm	TRIAC
						36°	2446lm	1877lm	1-10V
						60°	2446lm	1946lm	DALI
	25W	34V	600mA	90	3000K	15°	2545lm	2197lm	ON-OFF
						20°	2545lm	1983lm	TRIAC
						36°	2545lm	1954lm	1-10V
						60°	2545lm	2025lm	DALI
	25W	34V	600mA	90	4000K	15°	2586lm	2232lm	ON-OFF
						20°	2586lm	2014lm	TRIAC
						36°	2586lm	1985lm	1-10V
						60°	2586lm	2057lm	DALI
KAS-TL10R-A-9330	30W	34V	700mA	90	2700K	15°	2853lm	1391lm	ON-OFF
						20°	2853lm	2183lm	TRIAC
						36°	2853lm	2123lm	1-10V
						60°	2853lm	2221lm	DALI
	30W	34V	700mA	90	3000K	15°	2970lm	2516lm	ON-OFF
						20°	2970lm	2273lm	TRIAC
						36°	2970lm	2211lm	1-10V
						60°	2970lm	2313lm	DALI
	30W	34V	700mA	90	4000K	15°	3018lm	2556lm	ON-OFF
						20°	3018lm	2309lm	TRIAC
						36°	3018lm	2246lm	1-10V
						60°	3018lm	2350lm	DALI

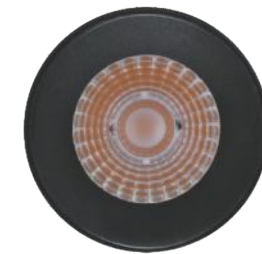

- Top brand high lumen COB LED, luminous efficiency of the whole lighting fixture can be above 85lm/w.
- Horizontal rotation 350° and vertical tilt 90°, achieving precise spotting angle.
- Anti-glare designed lamp body.
- Use high quality die-casting aluminium heat sink with convection cooling method, cooling fast to low down luminous decay efficiently.
- Same light with track, recessed, and mounted installation method.

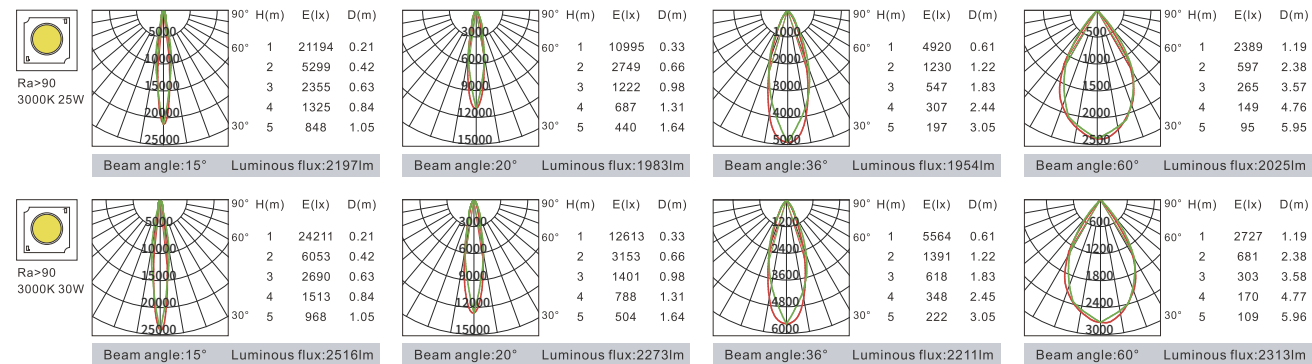

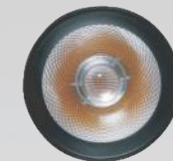
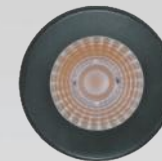
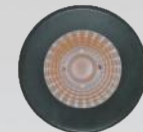

KAS-TL10L-C-50
Power: 7W
Diameter: 50mm
Cutout: 85-90mm

KAS-TL10L-C-66
Power: 10W/15W
Diameter: 66mm
Cutout: 85-90mm

KAS-TL10L-C-80
Power: 25W/30W
Diameter: 80mm
Cutout: 85-90mm

KAS-TL10R-C-80
Power: 25W/30W
Diameter: 80mm
Cutout: 85-90mm

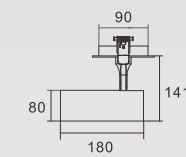
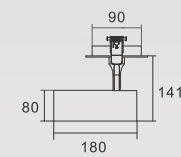
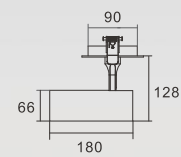
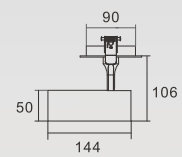

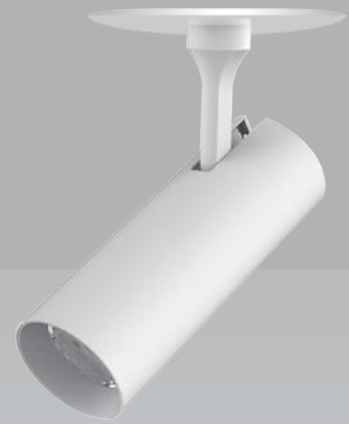

KAS-TL10L-C-50
Power: 7W
Diameter: 50mm
Cutout: 85-90mm

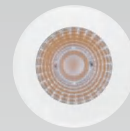
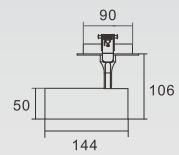

KAS-TL10L-C-66
Power: 10W/15W
Diameter: 66mm
Cutout: 85-90mm

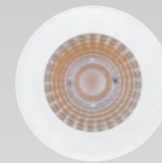
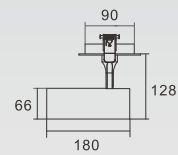

KAS-TL10L-C-80
Power: 25W/30W
Diameter: 80mm
Cutout: 85-90mm

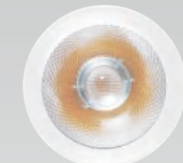
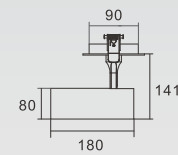

KAS-TL10R-C-80
Power: 25W/30W
Diameter: 80mm
Cutout: 85-90mm

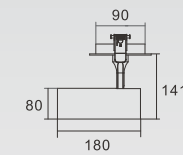

TL 10 Series
Recessed Spotlight

Model	KAS-TL10L-C-50	KAS-TL10L-C-66	KAS-TL10L-C-80	KAS-TL10R-C-80	KAS-TL10L-C-50	KAS-TL10L-C-66	KAS-TL10L-C-80	KAS-TL10R-C-80
Product Photo								
Dimension(mm)								
Cutout(mm)	85-90	85-90	85-90	85-90	85-90	85-90	85-90	85-90
Wattage	7W	10W/15W	25W/30W	25W/30W	7W	10W/15W	25W/30W	25W/30W
CCT	3000K/3500K/4000K	3000K/3500K/4000K	3000K/3500K/4000K	3000K/3500K/4000K	3000K/3500K/4000K	3000K/3500K/4000K	3000K/3500K/4000K	3000K/3500K/4000K
CRI	>90	>90	>90	>90	>90	>90	>90	>90
Beam Angle	10°/15°/20°/30°	10°/15°/20°/36°	10°/15°/20°/36°	20°/24°/30°/36°	10°/15°/20°/30°	10°/15°/20°/36°	10°/15°/20°/36°	20°/24°/30°/36°
Lumen	385LM	800-1125LM	2125-2400LM	2000-2250LM	385LM	800-1125LM	2125-2400LM	2000-2250LM
IP	IP 20	IP 20	IP 20	IP 20	IP 20	IP 20	IP 20	IP 20
Dimming	TRIAC/1-10V/DALI	TRIAC/1-10V/DALI	TRIAC/1-10V/DALI	TRIAC/1-10V/DALI	TRIAC/1-10V/DALI	TRIAC/1-10V/DALI	TRIAC/1-10V/DALI	TRIAC/1-10V/DALI
Accessory	Honeycomb Filter Stripped Glass Fabric Glass	Honeycomb Filter Stripped Glass Fabric Glass	Honeycomb Filter Stripped Glass Fabric Glass	Honeycomb Filter Stripped Glass Fabric Glass	Honeycomb Filter Stripped Glass Fabric Glass	Honeycomb Filter Stripped Glass Fabric Glass	Honeycomb Filter Stripped Glass Fabric Glass	Honeycomb Filter Stripped Glass Fabric Glass
Colour	Black/White	Black/White	Black/White	Black/White	Black/White	Black/White	Black/White	Black/White

Optical Accessories

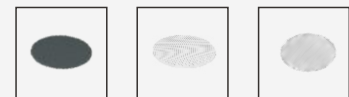

Honeycomb Filter Stripped Glass Fabric Glass

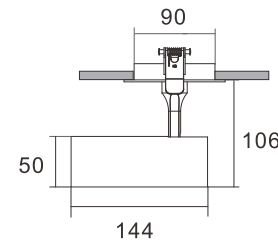
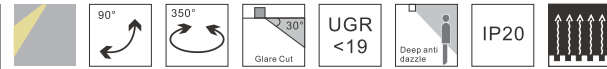

⌀ 85-90

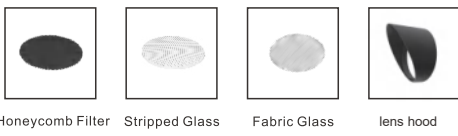

Model	Power	LED voltage	LED Current	CRI	CCT	Beam Angle	LED Output	System output	Dimming Type
KAS-TL10L-C-5007	7W	34V	150mA	90	2700K	10°	835lm	718lm	ON-OFF
						15°	835lm	743lm	TRIAC
						20°	835lm	760lm	1-10V
						30°	835lm	725lm	DALI
	7W	34V	150mA	90	3000K	10°	860lm	740lm	ON-OFF
						15°	860lm	766lm	TRIAC
						20°	860lm	783lm	1-10V
						30°	860lm	747lm	DALI
	7W	34V	150mA	90	4000K	10°	872lm	750lm	ON-OFF
						15°	872lm	776lm	TRIAC
						20°	872lm	793lm	1-10V
						30°	872lm	757lm	DALI

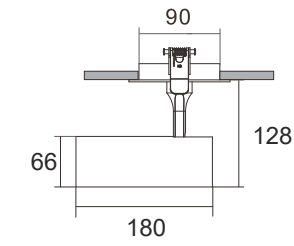
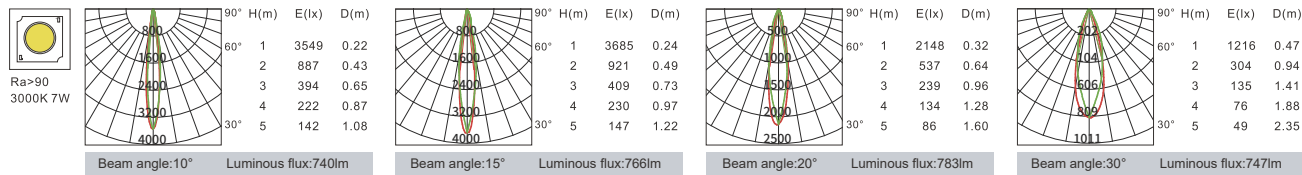

⌀ 85-90

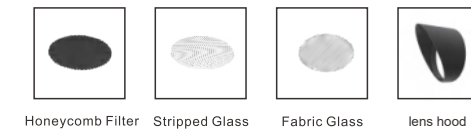

Model	Power	LED voltage	LED Current	CRI	CCT	Beam Angle	LED Output	System output	Dimming Type
KAS-TL10L-C-6610	10W	34V	250mA	90	2700K	10°	1058lm	761lm	ON-OFF
						15°	1058lm	806lm	TRIAC
						20°	1058lm	717lm	1-10V
						36°	1058lm	790lm	DALI
	10W	34V	250mA	90	3000K	10°	1099lm	791lm	ON-OFF
						15°	1099lm	837lm	TRIAC
						20°	1099lm	745lm	1-10V
						36°	1099lm	821lm	DALI
	10W	34V	250mA	90	4000K	10°	1118lm	804lm	ON-OFF
						15°	1118lm	851lm	TRIAC
						20°	1118lm	757lm	1-10V
						36°	1118lm	835lm	DALI
KAS-TL10L-C-6615	15W	34V	350mA	90	2700K	10°	1482lm	960lm	ON-OFF
						15°	1482lm	1031lm	TRIAC
						20°	1482lm	918lm	1-10V
						36°	1482lm	1006lm	DALI
	15W	34V	350mA	90	3000K	10°	1538lm	997lm	ON-OFF
						15°	1538lm	1070lm	TRIAC
						20°	1538lm	953lm	1-10V
						36°	1538lm	1045lm	DALI
	15W	34V	350mA	90	4000K	10°	1564lm	1013lm	ON-OFF
						15°	1564lm	1080lm	TRIAC
						20°	1564lm	969lm	1-10V
						36°	1564lm	1062lm	DALI

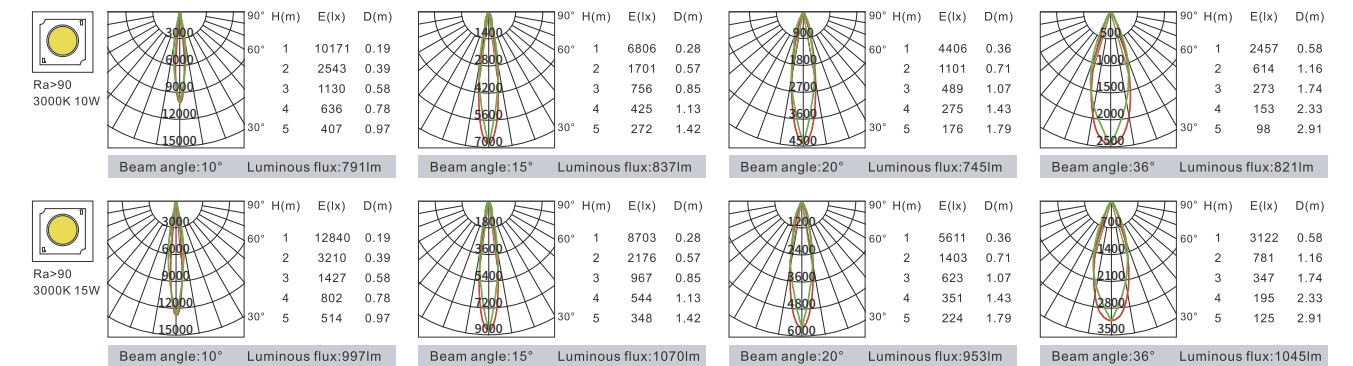

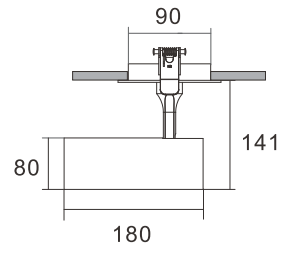
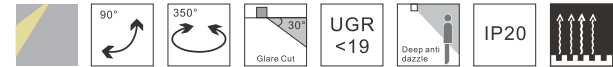

Ø 85-90

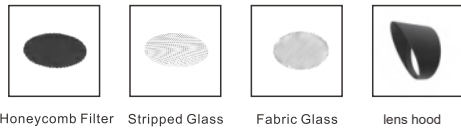

Model	Power	LED voltage	LED Current	CRI	CCT	Beam Angle	LED Output	System output	Dimming Type
KAS-TL10L-C-8025	25W	34V	600mA	90	2700K	10°	2446lm	1604lm	ON-OFF
						15°	2446lm	1948lm	TRIAC
						20°	2446lm	1809lm	1-10V
						36°	2446lm	1881lm	DALI
	25W	34V	600mA	90	3000K	10°	2545lm	1666lm	ON-OFF
						15°	2545lm	2027lm	TRIAC
						20°	2545lm	1883lm	1-10V
						36°	2545lm	1885lm	DALI
	25W	34V	600mA	90	4000K	10°	2586lm	1692lm	ON-OFF
						15°	2586lm	2059lm	TRIAC
						20°	2586lm	1913lm	1-10V
						36°	2586lm	1915lm	DALI
KAS-TL10L-C-8030	30W	34V	700mA	90	2700K	15°	2853lm	2164lm	ON-OFF
						20°	2853lm	2048lm	TRIAC
						36°	2853lm	2226lm	1-10V
									DALI
	30W	34V	700mA	90	3000K	15°	2970lm	2253lm	ON-OFF
						20°	2970lm	2133lm	TRIAC
						36°	2970lm	2138lm	1-10V
									DALI
	30W	34V	700mA	90	4000K	15°	3018lm	2289lm	ON-OFF
						20°	3018lm	2167lm	TRIAC
						36°	3018lm	2170lm	1-10V
									DALI

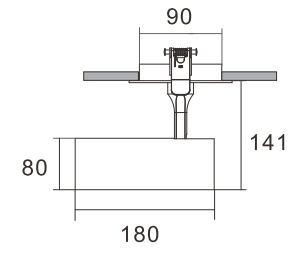
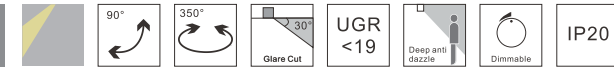
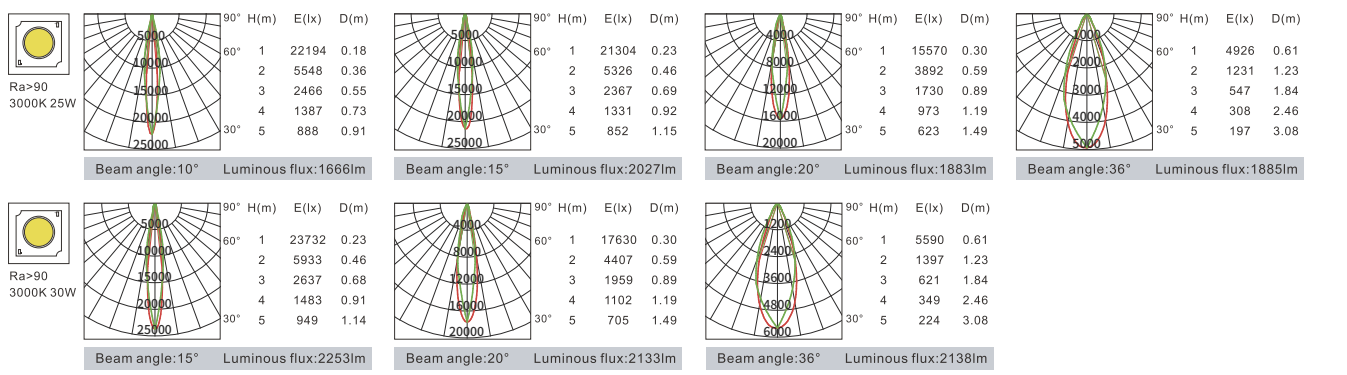

Ø 85-90

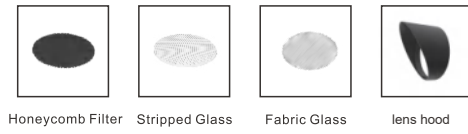

Model	Power	LED voltage	LED Current	CRI	CCT	Beam Angle	LED Output	System output	Dimming Type
KAS-TL10R-C-8025	25W	34V	600mA	90	2700K	20°	2446lm	1864lm	ON-OFF
						24°	2446lm	1840lm	TRIAC
						30°	2446lm	1801lm	1-10V
						36°	2446lm	1862lm	DALI
	25W	34V	600mA	90	3000K	20°	2545lm	1940lm	ON-OFF
						24°	2545lm	1915lm	TRIAC
						30°	2545lm	1874lm	1-10V
						36°	2545lm	1938lm	DALI
	25W	34V	600mA	90	4000K	20°	2586lm	1971lm	ON-OFF
						24°	2586lm	1945lm	TRIAC
						30°	2586lm	1904lm	1-10V
						36°	2586lm	1969lm	DALI
KAS-TL10R-C-8030	30W	34V	700mA	90	2700K	20°	2853lm	2115lm	ON-OFF
						24°	2853lm	2088lm	TRIAC
						30°	2853lm	2046lm	1-10V
						36°	2853lm	2084lm	DALI
	30W	34V	700mA	90	3000K	20°	2970lm	2202lm	ON-OFF
						24°	2970lm	2174lm	TRIAC
						30°	2970lm	2130lm	1-10V
						36°	2970lm	2170lm	DALI
	30W	34V	700mA	90	4000K	20°	3018lm	2237lm	ON-OFF
						24°	3018lm	2209lm	TRIAC
						30°	3018lm	2164lm	1-10V
						36°	3018lm	2205lm	DALI

