



With compact design, bar light has comfortable light for small space, bar counter of guest room, internal of cabinet and so on.



Black



Highly specular aluminium



White



Gold



- Selective chip with Ra>90
- The minimum cutout size is 17mm, small and delicate.
- The total height of the light is only 13.5mm, suitable for ceiling which has small space inside and will not damage the ceiling.
- Use good quality aluminum alloy die-casting lamp body, high efficiency heat dissipation.
- Anti-glare designed lamp body, shading angle $\geq 30^\circ$, UGR ≤ 19
- Clips installation design, simple and easy installation.



K-CL25-0502F-R2B
Power: 2W
Cutout: 17mm
Height: 30.7mm

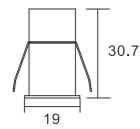

K-CL25-1002F-R2B
Power: 2W
Cutout: 25mm
Height: 38.7mm

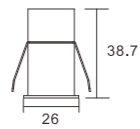

K-CL25-1503F-R2B
Power: 3W
Cutout: 35mm
Height: 51.5mm

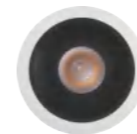
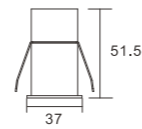

K-CL25-2F-R2D
Power: 3W/5W
Cutout: 45mm
Height: 62mm

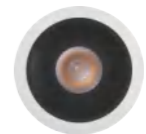
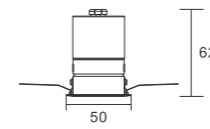

K-CL25-2F-R2D
Power: 8W
Cutout: 45mm
Height: 74mm

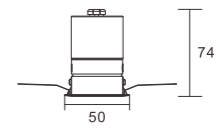

Model	K-CL25-0502F-R2B	K-CL25-1002F-R2B	K-CL25-1503F-R2B		K-CL25-2F-R2D	K-CL25-2F-R2D	K-CL25-C-3805	K-CL25-D-3805
Product Photo								
Dimension(mm)								
Cutout(mm)	17	25	35		45	45	45	45
Wattage	2W	2W	3W		3W/5W	8W	3W/5W	8W
CCT	2700K/3000K/3500K/4000K/5000K	2700K/3000K/3500K/4000K/5000K	2700K/3000K/3500K/4000K/5000K		2700K/3000K/3500K/4000K	2700K/3000K/3500K/4000K	2700K/3000K/3500K/4000K	2700K/3000K/3500K/4000K
CRI	>90	>90	>90		>90	>90	>90	>90
Beam Angle	20°/25°	20°/25°	11°/20°/25°		15°/30°/36°	15°/30°/36°	15°/30°/36°	15°/30°/36°
Lumen	70LM	70LM	180LM		150-250LM	400LM	268-352LM	268-352LM
IP	IP 20	IP 20	IP 20		IP 20	IP 20	IP 20	IP 20
Dimming			TRIAC/1-10V/DALI		TRIAC/1-10V/DALI	TRIAC/1-10V/DALI	TRIAC/1-10V/DALI	TRIAC/1-10V/DALI
Reflector Colour					Black/White/Gold/Highly specular aluminium	Black/White/Gold/Highly specular aluminium	Black/White/Gold/Highly specular aluminium	Black/White/Gold/Highly specular aluminium
Colour	White+Black	White+Black	White+Black		White+Iron gray	White+Iron gray	White+Iron gray	White+Iron gray

Reflecting Accessories



Highly specular aluminium

Black

Gold

White

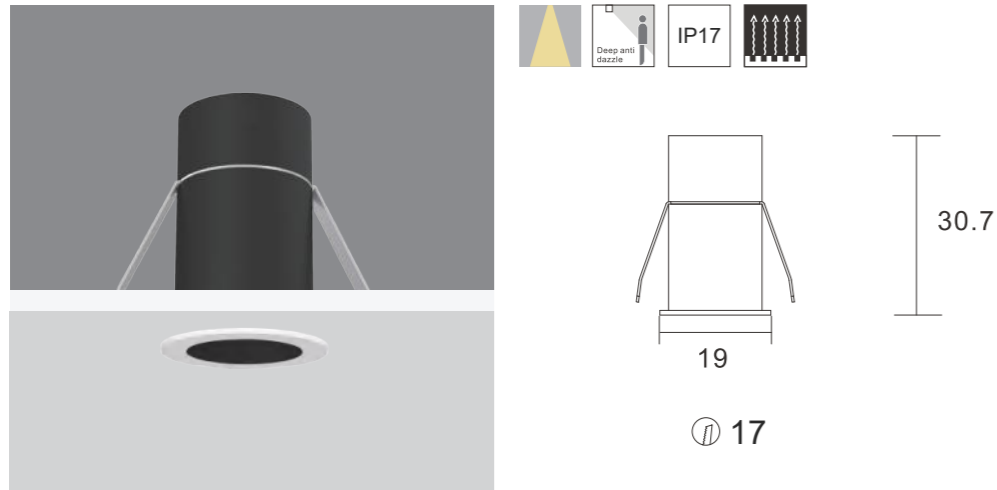

Model	Power	LED voltage	LED Current	CRI	CCT	Beam Angle	LED Output	System output	Dimming Type
K-CL25-0502F-R2B	2W	3V	350mA	90	2700K	20° 25°	135lm 135lm	40lm 61lm	ON-OFF
	2W	3V	350mA	90	3000K	20° 25°	145lm 145lm	44lm 66lm	ON-OFF
	2W	3V	350mA	90	4000K	20° 25°	157lm 157lm	47lm 71lm	ON-OFF

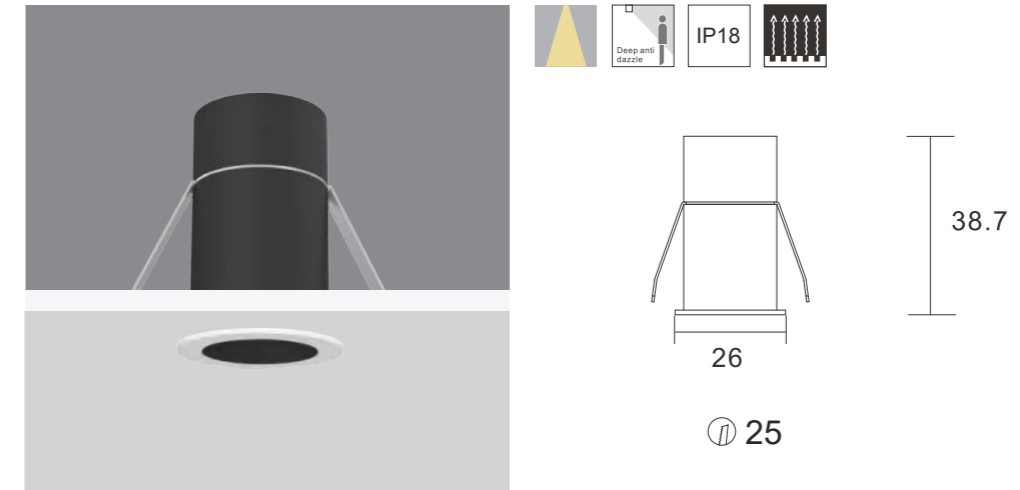
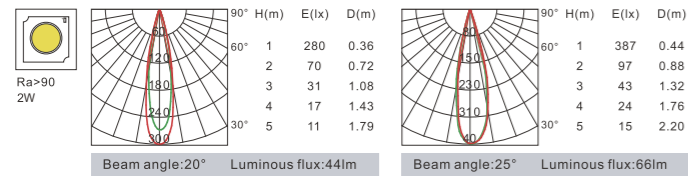

Model	Power	LED voltage	LED Current	CRI	CCT	Beam Angle	LED Output	System output	Dimming Type
K-CL25-1002F-R2B	2W	3V	350mA	90	2700K	20° 25°	135lm 135lm	55lm 66lm	ON-OFF
	2W	3V	350mA	90	3000K	20° 25°	145lm 145lm	60lm 71lm	ON-OFF
	2W	3V	350mA	90	4000K	20° 25°	157lm 157lm	64lm 76lm	ON-OFF

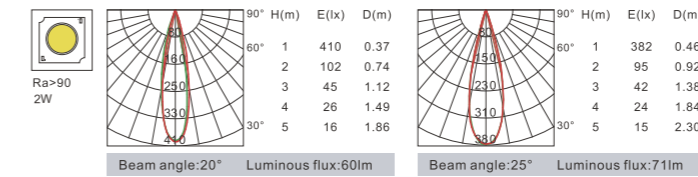

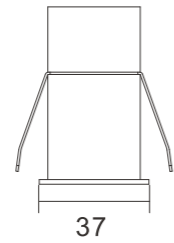
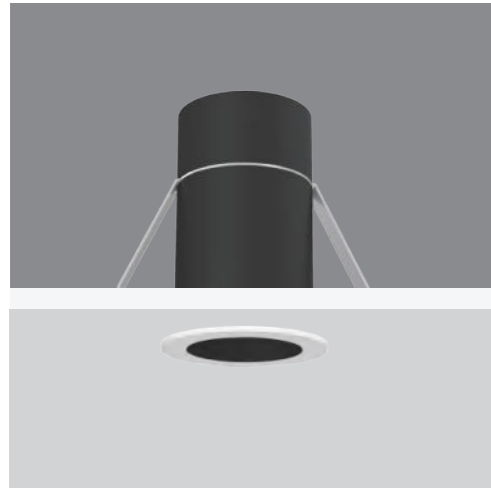

⌀ 35

Model	Power	LED voltage	LED Current	CRI	CCT	Beam Angle	LED Output	System output	Dimming Type
K-CL25-1503F-R2B	3W	3V	700mA	90	2700K	11°	198lm	146lm	ON-OFF
						20°	198lm	168lm	
						25°	198lm	60lm	
	3W	3V	700mA	90	3000K	11°	213lm	158lm	ON-OFF
						20°	213lm	181lm	
						25°	213lm	65lm	
	3W	3V	700mA	90	4000K	11°	231lm	171lm	ON-OFF
						20°	231lm	196lm	
						25°	231lm	70lm	

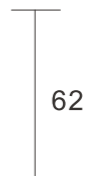
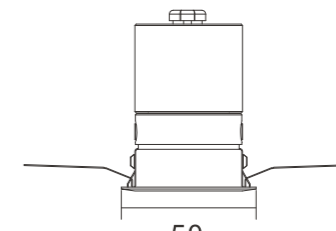
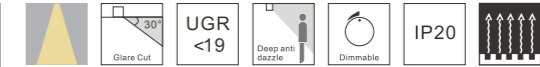
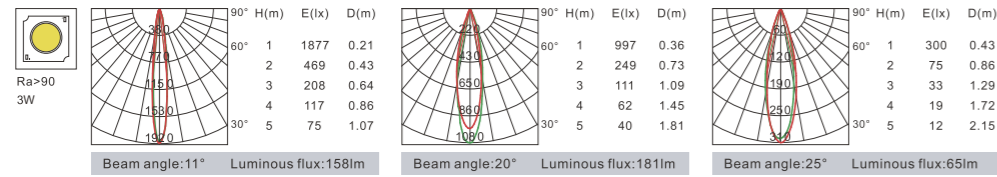

⌀ 45



Model	Power	LED voltage	LED Current	CRI	CCT	Beam Angle	LED Output	System output	Dimming Type
K-CL25-203F-R2D	3W	3V	700mA	90	2700K	15°	190lm	134lm	ON-OFF TRIAC 1-10V
						30°	190lm	134lm	
						36°	190lm	169lm	
	3W	3V	700mA	90	3000K	15°	213lm	151lm	ON-OFF TRIAC 1-10V
						30°	213lm	151lm	
						36°	213lm	136lm	
	3W	3V	700mA	90	4000K	15°	231lm	163lm	ON-OFF TRIAC 1-10V
						30°	231lm	163lm	
						36°	231lm	147lm	
K-CL25-205F-R2D	5W	36V	120mA	90	2700K	15°	445lm	195lm	ON-OFF TRIAC 1-10V DALI
						30°	445lm	194lm	
						36°	445lm	174lm	
	5W	36V	120mA	90	3000K	15°	462lm	203lm	ON-OFF TRIAC 1-10V DALI
						30°	462lm	202lm	
						36°	462lm	181lm	
	5W	36V	120mA	90	4000K	15°	484lm	212lm	ON-OFF TRIAC 1-10V DALI
						30°	484lm	211lm	
						36°	484lm	189lm	

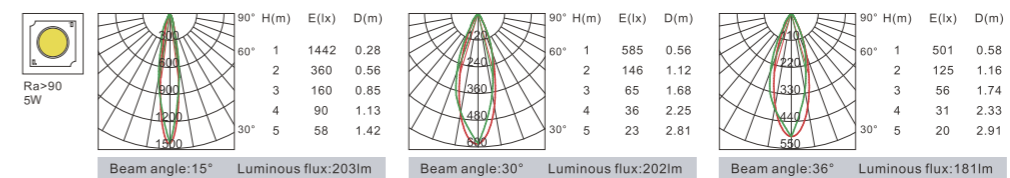
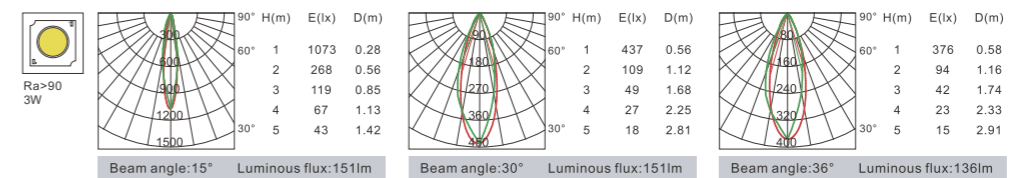

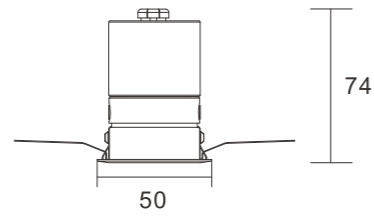

⌀ 45



Model	Power	LED voltage	LED Current	CRI	CCT	Beam Angle	LED Output	System output	Dimming Type
K-CL25-208F-R2D	8W	36V	200mA	90	2700K	15°	741lm	310lm	ON-OFF
						30°	741lm	310lm	TRIAC
						36°	741lm	282lm	1-10V DALI
	8W	36V	200mA	90	3000K	15°	770lm	323lm	ON-OFF
						30°	770lm	323lm	TRIAC
						36°	770lm	294lm	1-10V DALI
	8W	36V	200mA	90	4000K	15°	806lm	338lm	ON-OFF
						30°	806lm	338lm	TRIAC
						36°	806lm	307lm	1-10V DALI

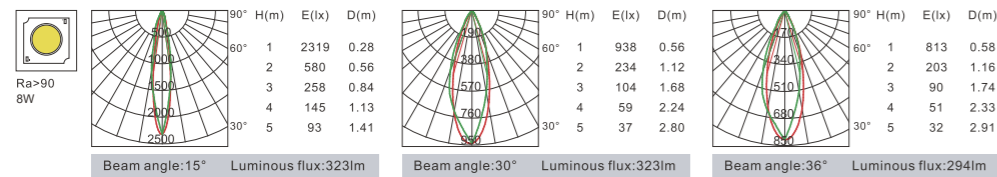

- Selective chip with Ra>90
- The minimum cutout size is 17mm, small and delicate.
- The total height of the light is only 13.5mm, suitable for ceiling which has small space inside and will not damage the ceiling.
- Use good quality aluminum alloy die-casting lamp body, high efficiency heat dissipation.
- Anti-glare designed lamp body, shading angle≥30°, UGR≤19
- Clips installation design, simple and easy installation.

Model	K-CL25-2T-R2	K-CL25-2T-R2D	K-CL25-2T-R2D	K-CL25-2T-R2D
Product Photo				
Dimension(mm)				
Cutout(mm)	45	45	45	45
Wattage	2W	2W	3W/5W	8W
CCT	2700K/3000K/4000K	2700K/3000K/4000K	2700K/3000K/3500K/4000K	2700K/3000K/3500K/4000K
CRI	>90	>90	>90	>90
Beam Angle	20°/30°/45°	20°/30°/45°	15°/30°/36°	15°/30°/36°
Lumen	100LM	100LM	150-250LM	400LM
IP	IP 20	IP 20	IP 20	IP 20
Dimming			TRIAC/1-10V/DALI	TRIAC/1-10V/DALI
Reflector Colour		Black White Gold Highly specular aluminium	Black White Gold Highly specular aluminium	Black White Gold Highly specular aluminium
Colour	White+Iron gray	White+Iron gray	White+Iron gray	White+Iron gray

Reflecting Accessories

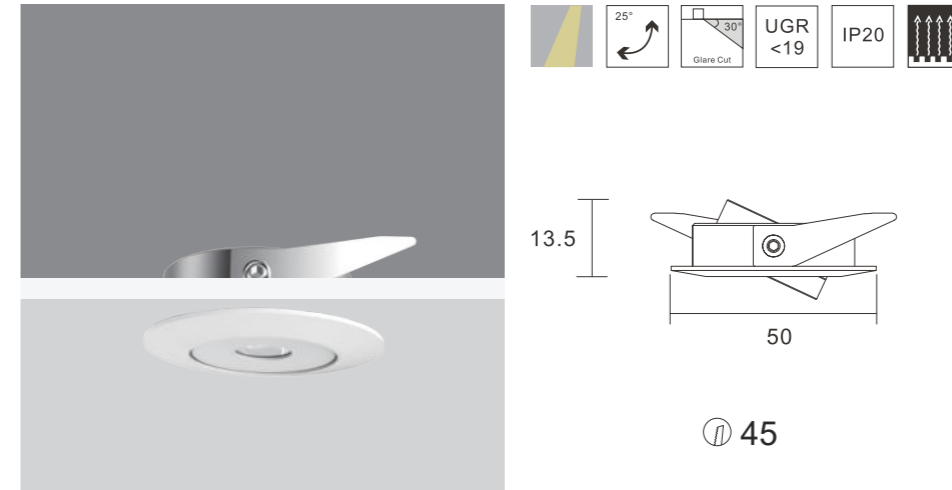

Model	Power	LED voltage	LED Current	CRI	CCT	Beam Angle	LED Output	System output	Dimming Type
K-CL25-202T-R2	2W	3V	350mA	90	2700K	20°	198lm	98lm	ON-OFF
						30°	198lm	81lm	
						45°	198lm	79lm	
	2W	3V	350mA	90	3000K	20°	213lm	106lm	ON-OFF
						30°	213lm	88lm	
						45°	213lm	86lm	
	2W	3V	350mA	90	4000K	20°	231lm	114lm	ON-OFF
						30°	231lm	95lm	
						45°	231lm	93lm	

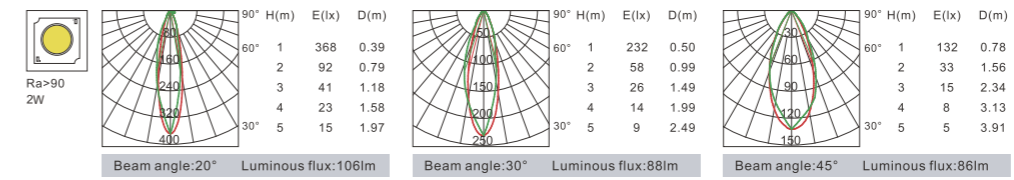

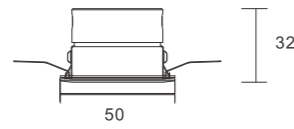
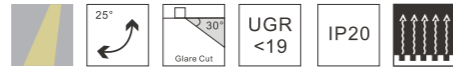

⌀ 45



Model	Power	LED voltage	LED Current	CRI	CCT	Beam Angle	LED Output	System output	Dimming Type
K-CL25-202T-R2D	2W	3V	350mA	90	2700K	20°	135lm	79lm	ON-OFF
						30°	135lm	72lm	
						45°	135lm	73lm	
	2W	3V	350mA	90	3000K	20°	145lm	85lm	ON-OFF
						30°	145lm	78lm	
						45°	145lm	79lm	
	2W	3V	350mA	90	4000K	20°	157lm	92lm	ON-OFF
						30°	157lm	84lm	
						45°	157lm	85lm	

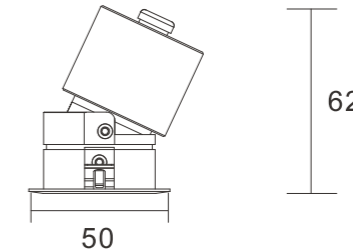
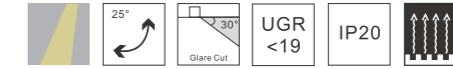
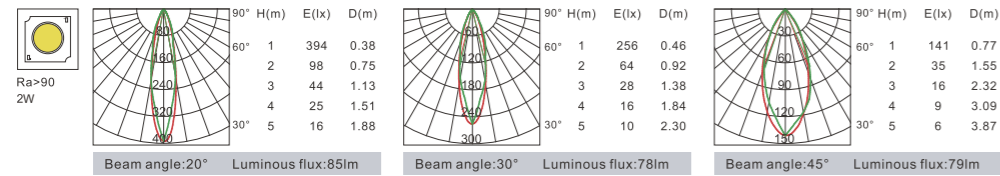

⌀ 45



Model	Power	LED voltage	LED Current	CRI	CCT	Beam Angle	LED Output	System output	Dimming Type
K-CL25-203T-R2D	3W	3V	700mA	90	2700K	20°	198lm	134lm	ON-OFF TRIAC 1-10V
						30°	198lm	134lm	
						45°	198lm	169lm	
	3W	3V	700mA	90	3000K	20°	213lm	151lm	ON-OFF TRIAC 1-10V
						30°	213lm	151lm	
						45°	213lm	136lm	
	3W	3V	700mA	90	4000K	20°	231lm	163lm	ON-OFF TRIAC 1-10V
						30°	231lm	163lm	
						45°	231lm	147lm	
K-CL25-205T-R2D	5W	36V	120mA	90	2700K	20°	445lm	195lm	ON-OFF TRIAC 1-10V DALI
						30°	445lm	194lm	
						45°	445lm	174lm	
5W	36V	120mA	90	3000K	20°	462lm	203lm	ON-OFF TRIAC 1-10V DALI	
					30°	462lm	202lm		
					45°	462lm	181lm		
5W	36V	120mA	90	4000K	20°	484lm	212lm	ON-OFF TRIAC 1-10V DALI	
					30°	484lm	211lm		
					45°	484lm	189lm		

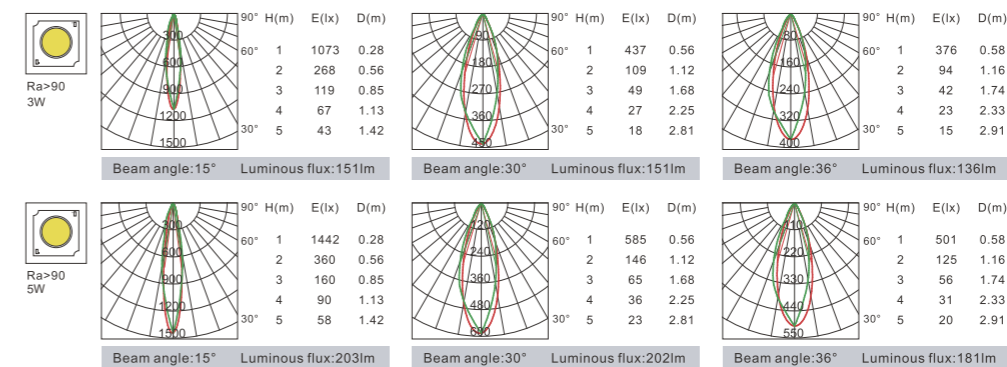

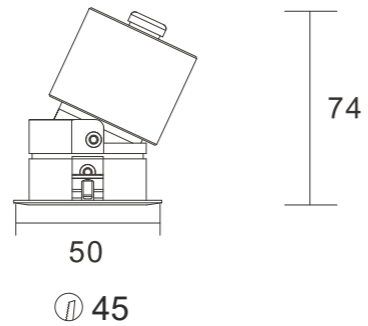

Model	Power	LED voltage	LED Current	CRI	CCT	Beam Angle	LED Output	System output	Dimming Type
K-CL25-208T-R2D	8W	36V	200mA	90	2700K	15°	741lm	310lm	ON-OFF TRIAC 1-10V DALI
						30°	741lm	310lm	
						36°	741lm	282lm	
	8W	36V	200mA	90	3000K	15°	770lm	323lm	ON-OFF TRIAC 1-10V DALI
						30°	770lm	323lm	
						36°	770lm	294lm	
	8W	36V	200mA	90	4000K	15°	806lm	338lm	ON-OFF TRIAC 1-10V DALI
						30°	806lm	338lm	
						36°	806lm	307lm	

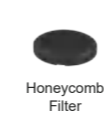
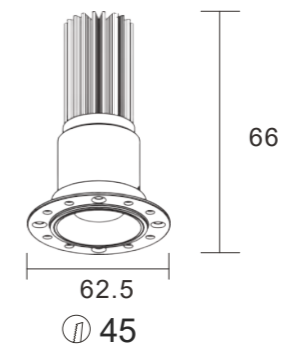
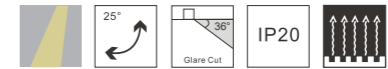
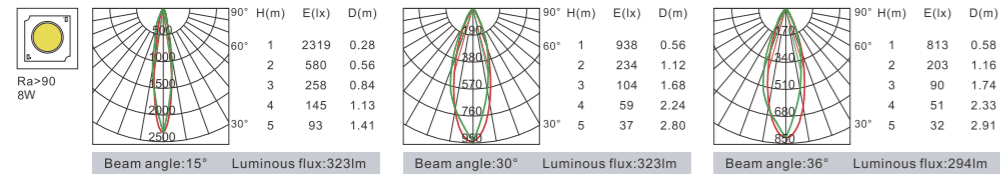

Model	Power	LED voltage	LED Current	CRI	CCT	Beam Angle	LED Output	System output	Dimming Type
K-CL25-208T-R3	8W	36V	200mA	90	2700K	18°	741lm	517lm	ON-OFF TRIAC 1-10V DALI
						24°	741lm	516lm	
						36°	741lm	564lm	
	8W	36V	200mA	90	3000K	18°	770lm	538lm	ON-OFF TRIAC 1-10V DALI
						24°	770lm	537lm	
						36°	770lm	587lm	
	8W	36V	200mA	90	4000K	18°	806lm	563lm	ON-OFF TRIAC 1-10V DALI
						24°	806lm	562lm	
						36°	806lm	614lm	
K-CL25-210T-R3	10W	36V	250mA	90	2700K	18°	927lm	624lm	ON-OFF TRIAC 1-10V DALI
						24°	927lm	621lm	
						36°	927lm	699lm	
10W	36V	250mA	90	3000K	18°	963lm	646lm	ON-OFF TRIAC 1-10V DALI	
					24°	963lm	646lm		
					36°	963lm	727lm		
10W	36V	250mA	90	4000K	18°	1008lm	676lm	ON-OFF TRIAC 1-10V DALI	
					24°	1008lm	676lm		
					36°	1008lm	760lm		

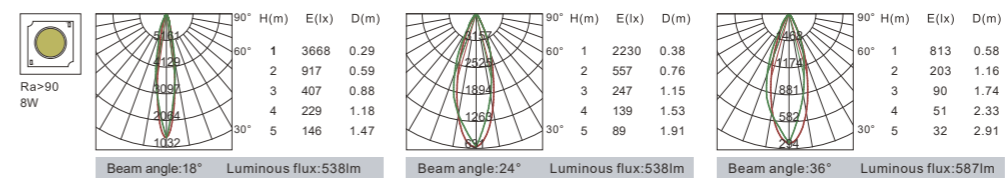

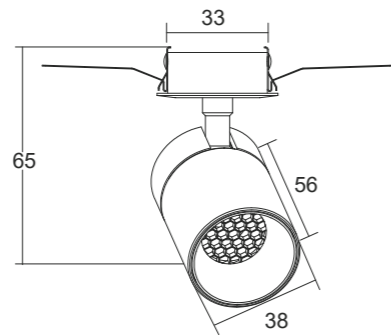
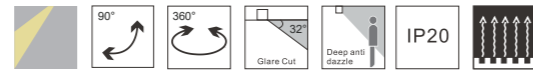

Model	Power	LED voltage	LED Current	CRI	CCT	Beam Angle	LED Output	System output	Dimming Type
K-CL25-C-3805	5W	9V	400mA	90	2700K	15°	310lm	268lm	ON-OFF TRIAC
						24°	310lm	281lm	1-10V
						36°	310lm	262lm	DALI
	5W	9V	400mA	90	3000K	15°	346lm	300lm	ON-OFF TRIAC
						24°	346lm	314lm	1-10V
						36°	346lm	293lm	DALI
	5W	9V	400mA	90	4000K	15°	416lm	676lm	ON-OFF TRIAC
						24°	416lm	377lm	1-10V
						36°	416lm	352lm	DALI

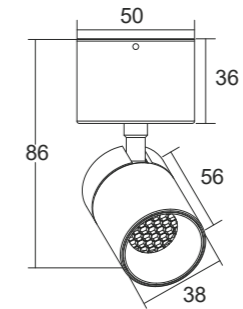
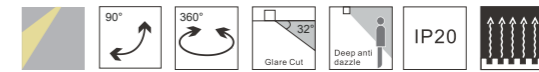
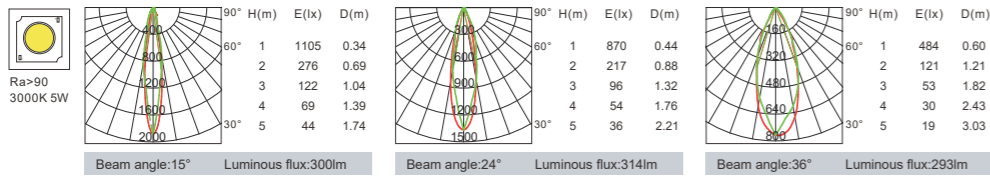

Model	Power	LED voltage	LED Current	CRI	CCT	Beam Angle	LED Output	System output	Dimming Type
K-CL25-D-3805	5W	9V	400mA	90	2700K	15°	310lm	268lm	ON-OFF TRIAC
						24°	310lm	281lm	1-10V
						36°	310lm	262lm	DALI
	5W	9V	400mA	90	3000K	15°	346lm	300lm	ON-OFF TRIAC
						24°	346lm	314lm	1-10V
						36°	346lm	293lm	DALI
	5W	9V	400mA	90	4000K	15°	416lm	676lm	ON-OFF TRIAC
						24°	416lm	377lm	1-10V
						36°	416lm	352lm	DALI

