



- Outstanding color rendition effect, meet the lighting demand of upscale places. 2700K/3000K/4000K, Ra>90
- Dark light technology with chip deeply hidden, well-designed dark light reflector with UGR<19. Comfortable and no glare.
- Conducts the heat from the chip effectively, and ensure the lamp performance and long lifespan.
- Precise distribution and even transition. Less scattering makes vision more comfortable.



KS-DL10L-C1-66

Power: 10W/15W  
Cutout: 90mm  
Height: 120mm

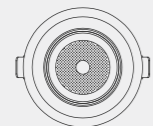
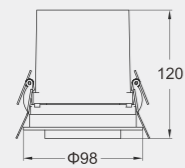

90mm

KS-DL10L-C2-66

Power: 2\*10W/2\*15W  
Cutout: 175\*90mm  
Height: 120mm

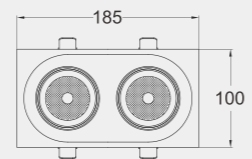
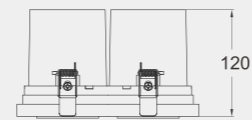

175\*90mm

KS-DL10L-C1-80

Power: 20W/30W  
Cutout: 120mm  
Height: 135mm

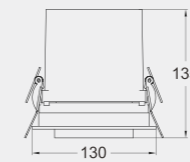

120mm

KS-DL10L-C2-80

Power: 2\*20W/2\*30W  
Cutout: 230\*120mm  
Height: 135mm

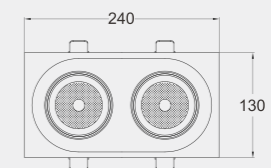
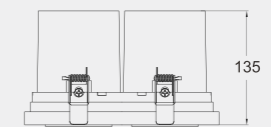

230\*120mm

Model	KS-DL10L-C1-66	KS-DL10L-C2-66	KS-DL10L-C1-80	KS-DL10L-C2-80		KS-DL10L-C1-2	KS-DL10L-C1-3	KS-DL10L-E1-2	KS-DL10L-E1-3
Product Photo									
Dimension(mm)									
Cutout(mm)	90	175*90	120	230*120		55	75	55	75
Wattage	10W/15W	2*10W/2*15W	20W/30W	2*20W/2*30W		10W/15W	10W/12W	5W/8W	10W/12W
CCT	2700K 3000K 3500K 4000K	2700K 3000K 3500K 4000K	2700K 3000K 3500K 4000K	2700K 3000K 3500K 4000K		2700K 3000K 3500K 4000K	2700K 3000K 3500K 4000K	2700K 3000K 3500K 4000K	2700K 3000K 3500K 4000K
CRI	>90	>90	>90	>90		>90	>90	>90	>90
Beam Angle	15°/24°/36°	15°/24°/36°	15°/24°/36°	15°/24°/36°		15°/24°/36°/50°	15°/24°/36°/50°	15°/24°/36°/50°	15°/24°/36°/50°
Lumen	618-1514LM	1211-3030LM	1567-2981LM	3151-5929LM		392-742LM	756-1083LM	392-742LM	758-1083LM
IP	IP20	IP20	IP20	IP20		IP20	IP20	IP20	IP20
Dimming	TRIAC/1-10V/DALL	TRIAC/1-10V/DALL	TRIAC/1-10V/DALL	TRIAC/1-10V/DALL		TRIAC/1-10V/DALL	TRIAC/1-10V/DALL	TRIAC/1-10V/DALL	TRIAC/1-10V/DALL
Accessory	Highly specular aluminium UV processed black cup Gold	Highly specular aluminium UV processed black cup Gold	Highly specular aluminium UV processed black cup Gold	Highly specular aluminium UV processed black cup Gold		Highly specular aluminium UV processed black cup Gold	Highly specular aluminium UV processed black cup Gold	Highly specular aluminium UV processed black cup Gold	Highly specular aluminium UV processed black cup Gold
Colour	White+black	White+black	White+black	White+black		White+black	White+black	White+black	White+black

Model	KS-DL10L-E2-2	KS-DL10L-E2-3	KS-DL10L-C2-2	KS-DL10L-C2-3		KS-DL10L-S2-2	KS-DL10L-S2-3	KS-DL10L-SE2-2	KS-DL10L-SE2-3
Product Photo									
Dimension(mm)									
Cutout(mm)	128.5*67.5	180*90.5	126*65	177.5*88		121.5*60	164*77	123.5*62.5	166.5*79.5
Wattage	10W/16W	20W/24W	10W/16W	20W/24W		10W/16W	20W/24W	10W/16W	20W/24W
CCT	2700K 3000K 3500K 4000K	2700K 3000K 3500K 4000K	2700K 3000K 3500K 4000K	2700K 3000K 3500K 4000K		2700K 3000K 3500K 4000K	2700K 3000K 3500K 4000K	2700K 3000K 3500K 4000K	2700K 3000K 3500K 4000K
CRI	>90	>90	>90	>90		>90	>90	>90	>90
Beam Angle	15°/24°/36°/50°	15°/24°/36°/50°	15°/24°/36°/50°	15°/24°/36°/50°		15°/24°/36°/50°	15°/24°/36°/50°	15°/24°/36°/50°	15°/24°/36°/50°
Lumen	784-1484LM	1512-2166LM	784-1484LM	1512-2166LM		784-1484LM	1512-2166LM	784-1484LM	1512-2166LM
IP	IP20	IP20	IP20	IP20		IP20	IP20	IP20	IP20
Dimming	TRIAC/1-10V/DALL	TRIAC/1-10V/DALL	TRIAC/1-10V/DALL	TRIAC/1-10V/DALL		TRIAC/1-10V/DALL	TRIAC/1-10V/DALL	TRIAC/1-10V/DALL	TRIAC/1-10V/DALL
Accessory Installation	Highly specular aluminium UV processed black cup Gold	Highly specular aluminium UV processed black cup Gold	Highly specular aluminium UV processed black cup Gold	Highly specular aluminium UV processed black cup Gold		Highly specular aluminium UV processed black cup Gold	Highly specular aluminium UV processed black cup Gold	Highly specular aluminium UV processed black cup Gold	Highly specular aluminium UV processed black cup Gold
Colour	White+black	White+black	White+black	White+black		White+black	White+black	White+black	White+black

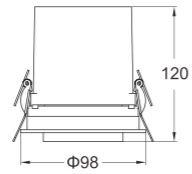

Φ 90-95mm



Model	Power	LED voltage	LED Current	CRI	CCT	Beam Angle	LED Output	System output	Dimming Type
KS-DL10L-C1-6610	10W	36V	250mA	90	2700K	15°	927lm	914lm	ON-OFF TRIAC
						24°	927lm	810lm	1-10V
						36°	927lm	618lm	DALI
	10W	36V	250mA	90	3000K	15°	963lm	950lm	ON-OFF TRIAC
						24°	963lm	842lm	1-10V
						36°	963lm	643lm	DALI
	10W	36V	250mA	90	4000K	15°	1008lm	994lm	ON-OFF TRIAC
						24°	1008lm	881lm	1-10V
						36°	1008lm	673lm	DALI
KS-DL10L-C1-6615	15W	36V	350mA	90	2700K	15°	1437lm	1289lm	ON-OFF TRIAC
						24°	1437lm	1140lm	1-10V
						36°	1437lm	1113lm	DALI
	15W	36V	350mA	90	3000K	15°	1638lm	1470lm	ON-OFF TRIAC
						24°	1638lm	1300lm	1-10V
						36°	1638lm	1269lm	DALI
	15W	36V	350mA	90	4000K	15°	1688lm	1514lm	ON-OFF TRIAC
						24°	1688lm	1339lm	1-10V
						36°	1688lm	1308lm	DALI

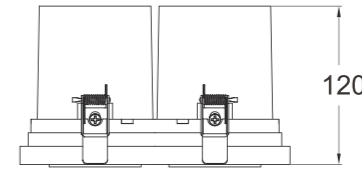
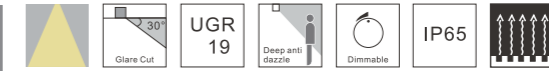
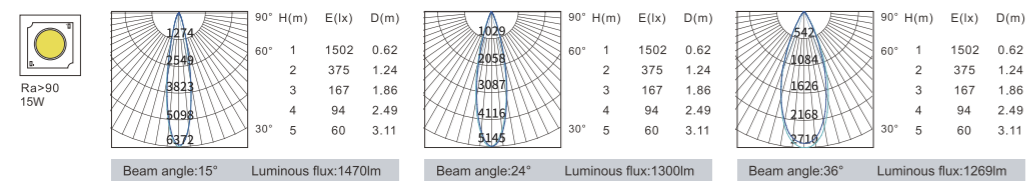
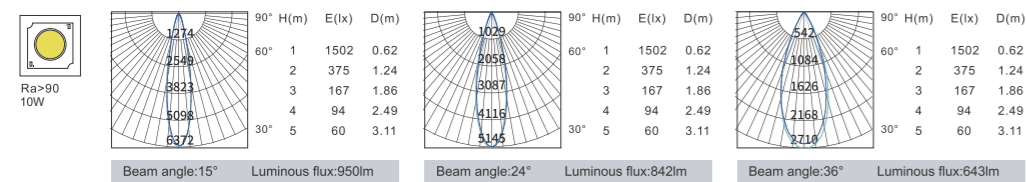

175\*90mm



Model	Power	LED voltage	LED Current	CRI	CCT	Beam Angle	LED Output	System output	Dimming Type
KS-DL10L-C2-6620	2*10W	36V	500mA	90	2700K	15°	1950lm	1789lm	ON-OFF TRIAC
						24°	1950lm	1586lm	1-10V
						36°	1950lm	1211lm	DALI
	2*10W	36V	500mA	90	3000K	15°	2070lm	1900lm	ON-OFF TRIAC
						24°	2070lm	1684lm	1-10V
						36°	2070lm	1286lm	DALI
	2*10W	36V	500mA	90	4000K	15°	2200lm	2019lm	ON-OFF TRIAC
						24°	2200lm	1789lm	1-10V
						36°	2200lm	1366lm	DALI
KS-DL10L-C2-6630	2*15W	36V	700mA	90	2700K	15°	2674lm	2579lm	ON-OFF TRIAC
						24°	2674lm	2281lm	1-10V
						36°	2674lm	2226lm	DALI
	2*15W	36V	700mA	90	3000K	15°	3274lm	2940lm	ON-OFF TRIAC
						24°	3274lm	2600lm	1-10V
						36°	3274lm	2538lm	DALI
	2*15W	36V	700mA	90	4000K	15°	3376lm	3030lm	ON-OFF TRIAC
						24°	3376lm	2676lm	1-10V
						36°	3376lm	2616lm	DALI

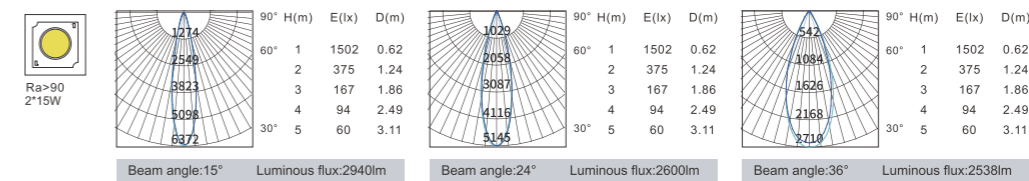
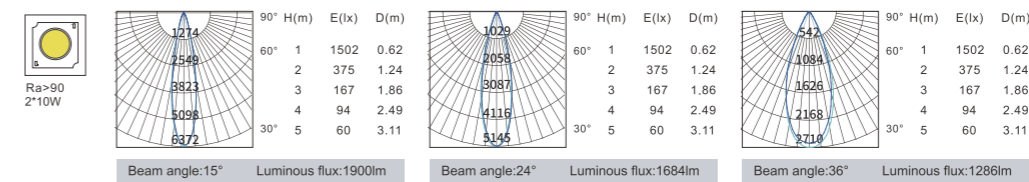

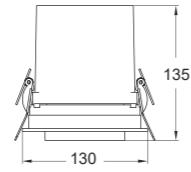

⌀ 120-125mm



Model	Power	LED voltage	LED Current	CRI	CCT	Beam Angle	LED Output	System output	Dimming Type
KS-DL10L-C1-8020	20W	36V	500mA	90	2700K	15°	1950lm	1789lm	ON-OFF TRIAC 1-10V DALI
						24°	1950lm	1639lm	
						36°	1950lm	1567lm	
	20W	36V	500mA	90	3000K	15°	2070lm	1900lm	ON-OFF TRIAC 1-10V DALI
						24°	2070lm	1740lm	
						36°	2070lm	1664lm	
	20W	36V	500mA	90	4000K	15°	2200lm	2019lm	ON-OFF TRIAC 1-10V DALI
						24°	2200lm	1849lm	
						36°	2200lm	1768lm	
KS-DL10L-C1-8030	30W	36V	700mA	90	2700K	15°	2820lm	2666lm	ON-OFF TRIAC 1-10V DALI
						24°	2820lm	2492lm	
						36°	2820lm	2367lm	
	30W	36V	700mA	90	3000K	15°	2980lm	2850lm	ON-OFF TRIAC 1-10V DALI
						24°	2980lm	2664lm	
						36°	2980lm	2531lm	
	30W	36V	700mA	90	4000K	15°	3090lm	2896lm	ON-OFF TRIAC 1-10V DALI
						24°	3090lm	2981lm	
						36°	3090lm	2845lm	

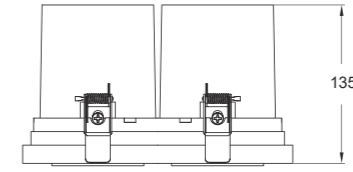
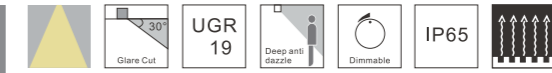
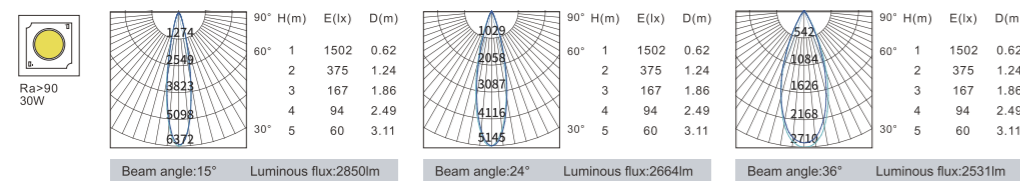
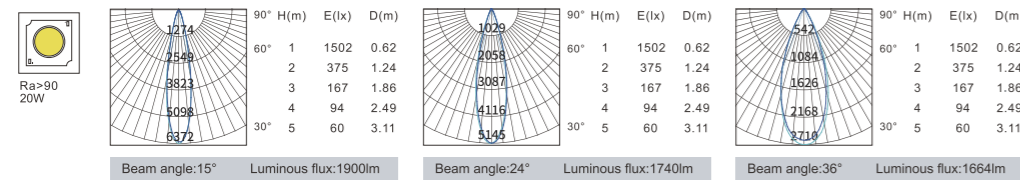

230\*120mm



Model	Power	LED voltage	LED Current	CRI	CCT	Beam Angle	LED Output	System output	Dimming Type
KS-DL10L-C2-8040	2*20W	36V	500mA	90	2700K	15°	3920lm	3598lm	ON-OFF TRIAC 1-10V DALI
						24°	3920lm	3295lm	
						36°	3920lm	3151lm	
	2*20W	36V	500mA	90	3000K	15°	4140lm	3800lm	ON-OFF TRIAC 1-10V DALI
						24°	4140lm	3480lm	
						36°	4140lm	3328lm	
	2*20W	36V	500mA	90	4000K	15°	4500lm	4129lm	ON-OFF TRIAC 1-10V DALI
						24°	4500lm	3781lm	
						36°	4500lm	3617lm	
KS-DL10L-C2-8060	2*30W	36V	700mA	90	2700K	15°	5654lm	5365lm	ON-OFF TRIAC 1-10V DALI
						24°	5654lm	5015lm	
						36°	5654lm	4765lm	
	2*30W	36V	700mA	90	3000K	15°	6006lm	5700lm	ON-OFF TRIAC 1-10V DALI
						24°	6006lm	5328lm	
						36°	6006lm	5062lm	
	2*30W	36V	700mA	90	4000K	15°	6248lm	5929lm	ON-OFF TRIAC 1-10V DALI
						24°	6248lm	5542lm	
						36°	6248lm	5265lm	

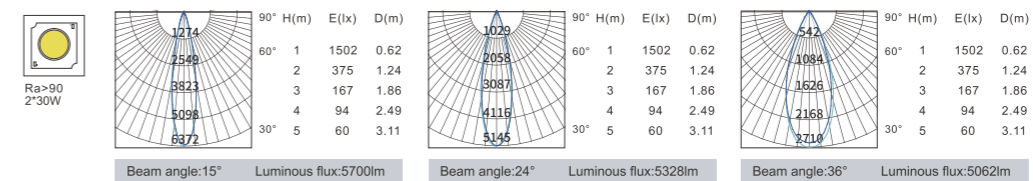
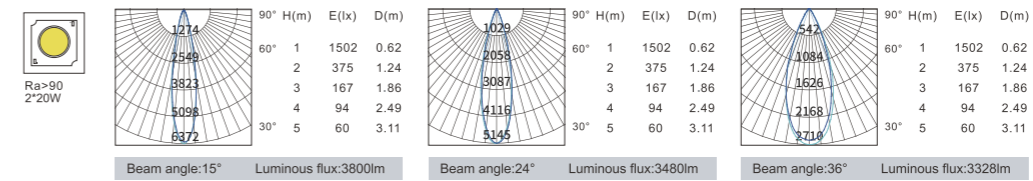

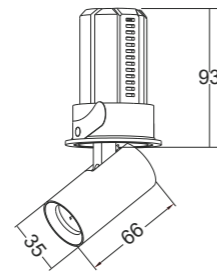
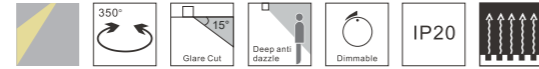

∅ 55mm

Model	Power	LED voltage	LED Current	CRI	CCT	Beam Angle	LED Output	System output	Dimming Type
KS-DL10L-C1-205	5W	36V	120mA	90	2700K	15°	415lm	392lm	ON-OFF
						24°	415lm	396lm	TRIAC
						36°	415lm	399lm	1-10V
						50°	415lm	402lm	DALI
	5W	36V	120mA	90	3000K	15°	440lm	416lm	ON-OFF
						24°	440lm	420lm	TRIAC
						36°	440lm	424lm	1-10V
						50°	440lm	427lm	DALI
	5W	36V	120mA	90	4000K	15°	465lm	439lm	ON-OFF
						24°	465lm	443lm	TRIAC
						36°	465lm	448lm	1-10V
						50°	465lm	451lm	DALI
KS-DL10L-C1-208	8W	36V	200mA	90	2700K	15°	691lm	618lm	ON-OFF
						24°	691lm	625lm	TRIAC
						36°	691lm	604lm	1-10V
						50°	691lm	661lm	DALI
	8W	36V	200mA	90	3000K	15°	733lm	656lm	ON-OFF
						24°	733lm	664lm	TRIAC
						36°	733lm	641lm	1-10V
						50°	733lm	702lm	DALI
	8W	36V	200mA	90	4000K	15°	775lm	693lm	ON-OFF
						24°	775lm	702lm	TRIAC
						36°	775lm	677lm	1-10V
						50°	775lm	742lm	DALI

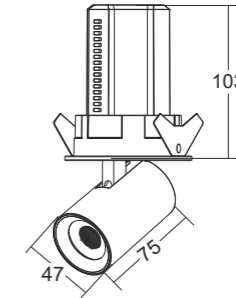
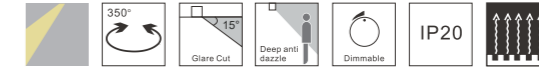
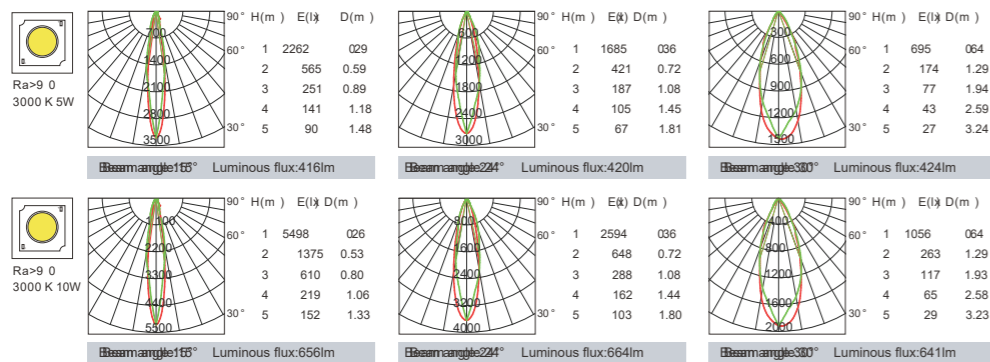

∅ 75mm

Model	Power	LED voltage	LED Current	CRI	CCT	Beam Angle	LED Output	System output	Dimming Type
KS-DL10L-C1-310	10W	36V	250mA	90	2700K	15°	864lm	756lm	ON-OFF
						24°	864lm	784lm	TRIAC
						36°	864lm	764lm	1-10V
						50°	864lm	767lm	DALI
	10W	36V	250mA	90	3000K	15°	916lm	802lm	ON-OFF
						24°	916lm	832lm	TRIAC
						36°	916lm	811lm	1-10V
						50°	916lm	814lm	DALI
	10W	36V	250mA	90	4000K	15°	968lm	876lm	ON-OFF
						24°	968lm	859lm	TRIAC
						36°	968lm	857lm	1-10V
						50°	968lm	860lm	DALI
KS-DL10L-C1-312	12W	36V	300mA	90	2700K	15°	1037lm	878lm	ON-OFF
						24°	1037lm	967lm	TRIAC
						36°	1037lm	947lm	1-10V
						50°	1037lm	904lm	DALI
	12W	36V	300mA	90	3000K	15°	1100lm	932lm	ON-OFF
						24°	1100lm	1026lm	TRIAC
						36°	1100lm	1005lm	1-10V
						50°	1100lm	959lm	DALI
	12W	36V	300mA	90	4000K	15°	1162lm	984lm	ON-OFF
						24°	1162lm	1083lm	TRIAC
						36°	1162lm	1061lm	1-10V
						50°	1162lm	1013lm	DALI

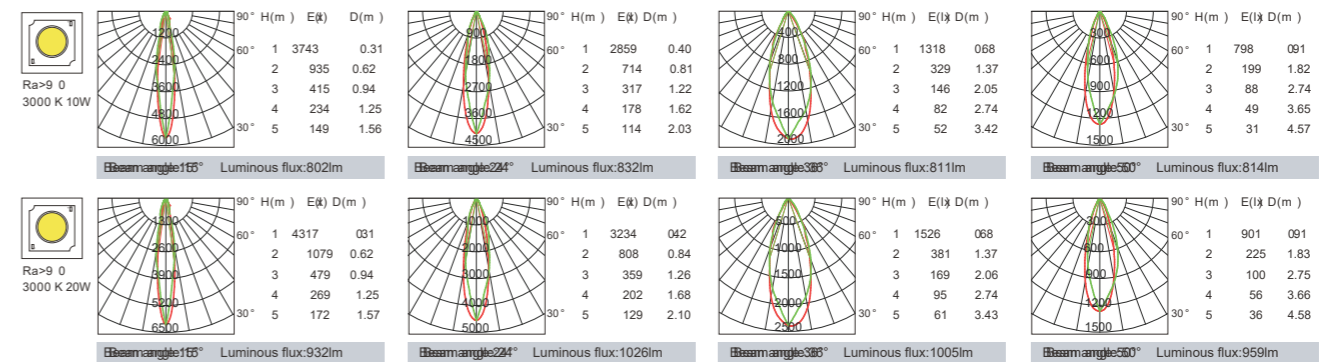

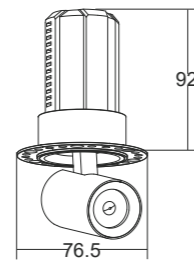
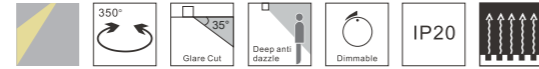

∅ 55mm

Model	Power	LED voltage	LED Current	CRI	CCT	Beam Angle	LED Output	System output	Dimming Type
KS-DL10L-E1-205	5W	36V	120mA	90	2700K	15°	415lm	392lm	ON-OFF
						24°	415lm	396lm	TRIAC
						36°	415lm	399lm	1-10V
						50°	415lm	402lm	DALI
	5W	36V	120mA	90	3000K	15°	440lm	416lm	ON-OFF
						24°	440lm	420lm	TRIAC
						36°	440lm	424lm	1-10V
						50°	440lm	427lm	DALI
	5W	36V	120mA	90	4000K	15°	465lm	439lm	ON-OFF
						24°	465lm	443lm	TRIAC
						36°	465lm	448lm	1-10V
						50°	465lm	451lm	DALI
KS-DL10L-E1-208	8W	36V	200mA	90	2700K	15°	691lm	618lm	ON-OFF
						24°	691lm	625lm	TRIAC
						36°	691lm	604lm	1-10V
						50°	691lm	661lm	DALI
	8W	36V	200mA	90	3000K	15°	733lm	656lm	ON-OFF
						24°	733lm	664lm	TRIAC
						36°	733lm	641lm	1-10V
						50°	733lm	702lm	DALI
	8W	36V	200mA	90	4000K	15°	775lm	693lm	ON-OFF
						24°	775lm	702lm	TRIAC
						36°	775lm	677lm	1-10V
						50°	775lm	742lm	DALI

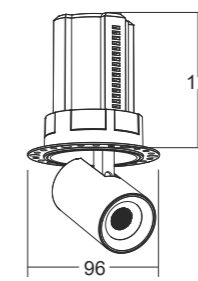
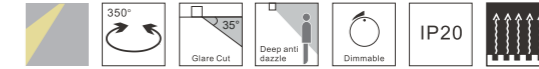
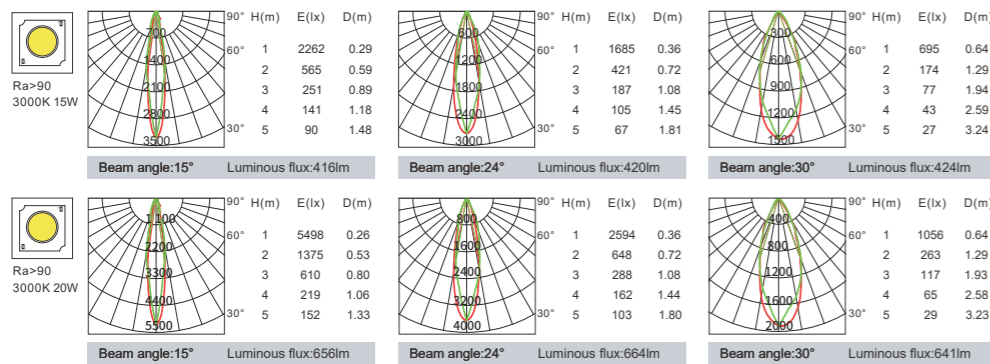

∅ 75mm

Model	Power	LED voltage	LED Current	CRI	CCT	Beam Angle	LED Output	System output	Dimming Type
KS-DL10L-E1-310	10W	36V	250mA	90	2700K	15°	864lm	756lm	ON-OFF
						24°	864lm	784lm	TRIAC
						36°	864lm	764lm	1-10V
						50°	864lm	767lm	DALI
	10W	36V	250mA	90	3000K	15°	916lm	802lm	ON-OFF
						24°	916lm	832lm	TRIAC
						36°	916lm	811lm	1-10V
						50°	916lm	814lm	DALI
	10W	36V	250mA	90	4000K	15°	968lm	876lm	ON-OFF
						24°	968lm	859lm	TRIAC
						36°	968lm	857lm	1-10V
						50°	968lm	860lm	DALI
KS-DL10L-E1-312	12W	36V	300mA	90	2700K	15°	1037lm	878lm	ON-OFF
						24°	1037lm	967lm	TRIAC
						36°	1037lm	947lm	1-10V
						50°	1037lm	904lm	DALI
	12W	36V	300mA	90	3000K	15°	1100lm	932lm	ON-OFF
						24°	1100lm	1026lm	TRIAC
						36°	1100lm	1005lm	1-10V
						50°	1100lm	959lm	DALI
	12W	36V	300mA	90	4000K	15°	1162lm	984lm	ON-OFF
						24°	1162lm	1083lm	TRIAC
						36°	1162lm	1061lm	1-10V
						50°	1162lm	1013lm	DALI

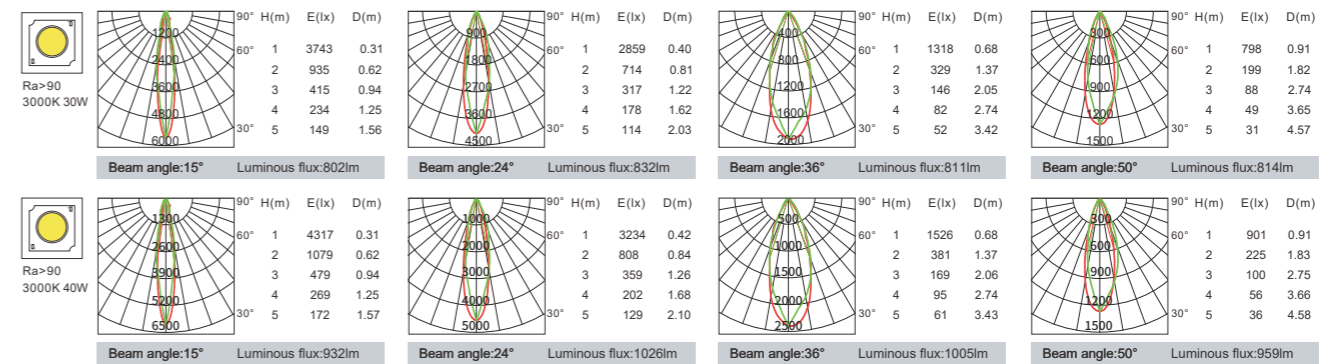



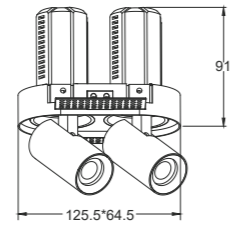
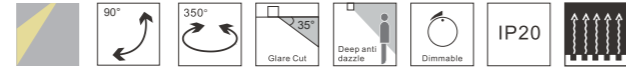
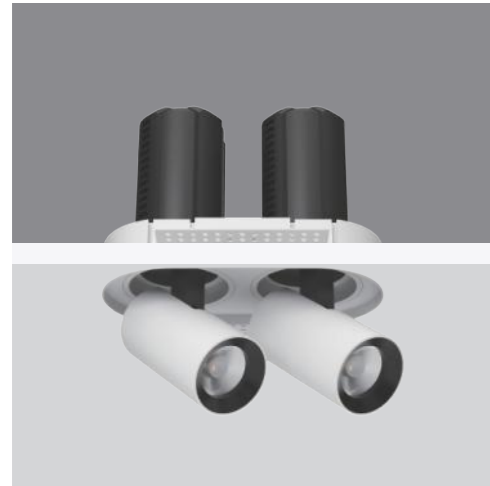

128.5\*67.5mm

Model	Power	LED voltage	LED Current	CRI	CCT	Beam Angle	LED Output	System output	Dimming Type
KS-DL10L-E2-210	10W	36V	2*120mA	90	2700K	15°	415*2lm	784lm	ON-OFF
						24°	415*2lm	792lm	TRIAC
						36°	415*2lm	798lm	1-10V
						50°	415*2lm	804lm	DALI
	10W	36V	2*120mA	90	3000K	15°	440*2lm	832lm	ON-OFF
						24°	440*2lm	840lm	TRIAC
						36°	440*2lm	848lm	1-10V
						50°	440*2lm	854lm	DALI
	10W	36V	2*120mA	90	4000K	15°	465*2lm	478lm	ON-OFF
						24°	465*2lm	886lm	TRIAC
						36°	465*2lm	896lm	1-10V
						50°	465*2lm	902lm	DALI
KS-DL10L-E2-216	16W	36V	2*200mA	90	2700K	15°	691*2lm	1236lm	ON-OFF
						24°	691*2lm	1250lm	TRIAC
						36°	691*2lm	1208lm	1-10V
						50°	691*2lm	1322lm	DALI
	16W	36V	2*200mA	90	3000K	15°	733*2lm	1312lm	ON-OFF
						24°	733*2lm	1328lm	TRIAC
						36°	733*2lm	1282lm	1-10V
						50°	733*2lm	1404lm	DALI
	16W	36V	2*200mA	90	4000K	15°	775*2lm	1386lm	ON-OFF
						24°	775*2lm	1404lm	TRIAC
						36°	775*2lm	1354lm	1-10V
						50°	775*2lm	1484lm	DALI

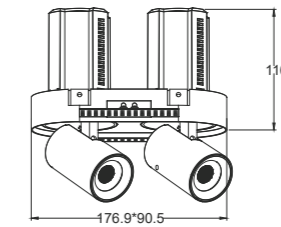
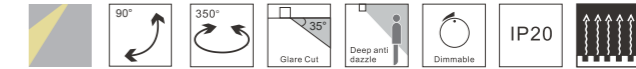
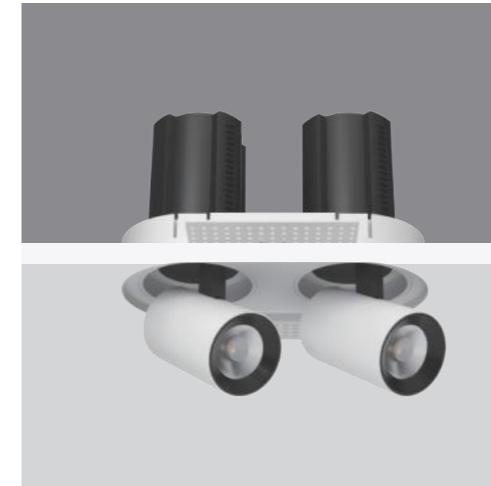
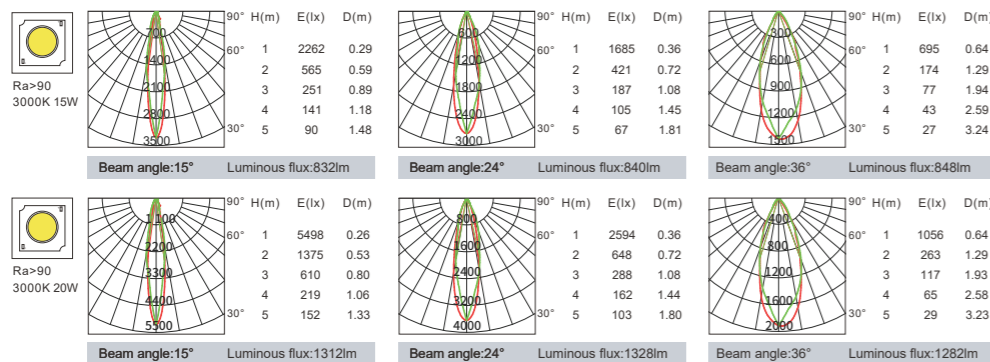

180\*90.5mm

Model	Power	LED voltage	LED Current	CRI	CCT	Beam Angle	LED Output	System output	Dimming Type
KS-DL10L-E2-320	20W	36V	2*250mA	90	2700K	15°	864*2lm	1512lm	ON-OFF
						24°	864*2lm	1568lm	TRIAC
						36°	864*2lm	1528lm	1-10V
						50°	864*2lm	1534lm	DALI
	20W	36V	2*250mA	90	3000K	15°	916*2lm	1604lm	ON-OFF
						24°	916*2lm	1668lm	TRIAC
						36°	916*2lm	1622lm	1-10V
						50°	916*2lm	1628lm	DALI
	20W	36V	2*250mA	90	4000K	15°	968*2lm	1752lm	ON-OFF
						24°	968*2lm	1718lm	TRIAC
						36°	968*2lm	1714lm	1-10V
						50°	968*2lm	1720lm	DALI
KS-DL10L-E2-324	24W	36V	2*300mA	90	2700K	15°	1037*2lm	1756lm	ON-OFF
						24°	1037*2lm	1934lm	TRIAC
						36°	1037*2lm	1894lm	1-10V
						50°	1037*2lm	1808lm	DALI
	24W	36V	2*300mA	90	3000K	15°	1100*2lm	1864lm	ON-OFF
						24°	1100*2lm	2052lm	TRIAC
						36°	1100*2lm	2010lm	1-10V
						50°	1100*2lm	1918lm	DALI
	24W	36V	2*300mA	90	4000K	15°	1162*2lm	1968lm	ON-OFF
						24°	1162*2lm	2166lm	TRIAC
						36°	1162*2lm	2122lm	1-10V
						50°	1162*2lm	2026lm	DALI

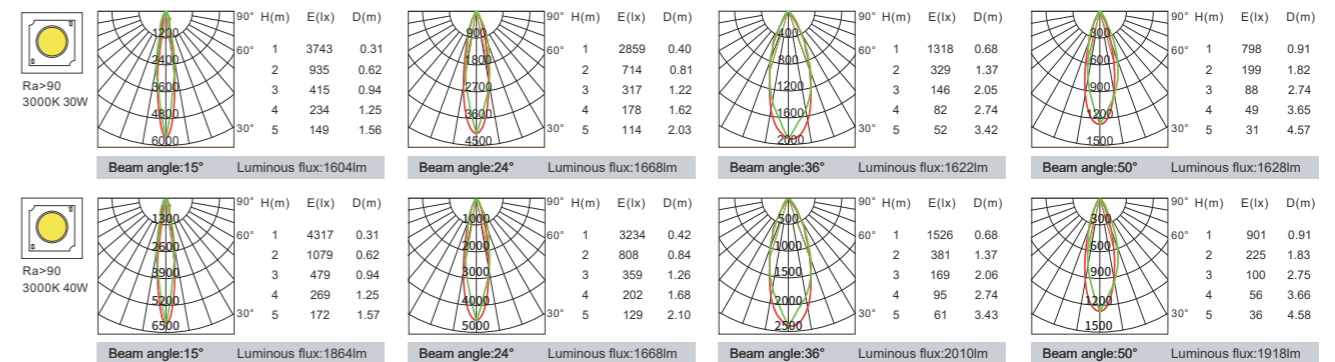

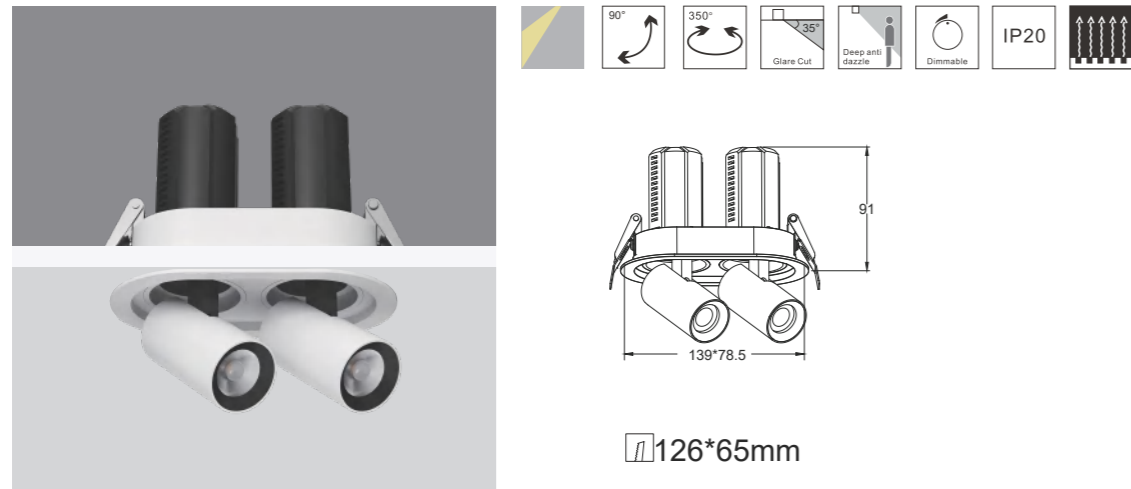

Model	Power	LED voltage	LED Current	CRI	CCT	Beam Angle	LED Output	System output	Dimming Type
KS-DL10L-C2-210	10W	36V	2*120mA	90	2700K	15°	415*2lm	784lm	ON-OFF
						24°	415*2lm	792lm	TRIAC
						36°	415*2lm	798lm	1-10V
						50°	415*2lm	804lm	DALI
	10W	36V	2*120mA	90	3000K	15°	440*2lm	832lm	ON-OFF
						24°	440*2lm	840lm	TRIAC
						36°	440*2lm	848lm	1-10V
						50°	440*2lm	854lm	DALI
	10W	36V	2*120mA	90	4000K	15°	465*2lm	478lm	ON-OFF
						24°	465*2lm	886lm	TRIAC
						36°	465*2lm	896lm	1-10V
						50°	465*2lm	902lm	DALI
KS-DL10L-C2-216	16W	36V	2*200mA	90	2700K	15°	691*2lm	1236lm	ON-OFF
						24°	691*2lm	1250lm	TRIAC
						36°	691*2lm	1208lm	1-10V
						50°	691*2lm	1322lm	DALI
	16W	36V	2*200mA	90	3000K	15°	733*2lm	1312lm	ON-OFF
						24°	733*2lm	1328lm	TRIAC
						36°	733*2lm	1282lm	1-10V
						50°	733*2lm	1404lm	DALI
	16W	36V	2*200mA	90	4000K	15°	775*2lm	1386lm	ON-OFF
						24°	775*2lm	1404lm	TRIAC
						36°	775*2lm	1354lm	1-10V
						50°	775*2lm	1484lm	DALI

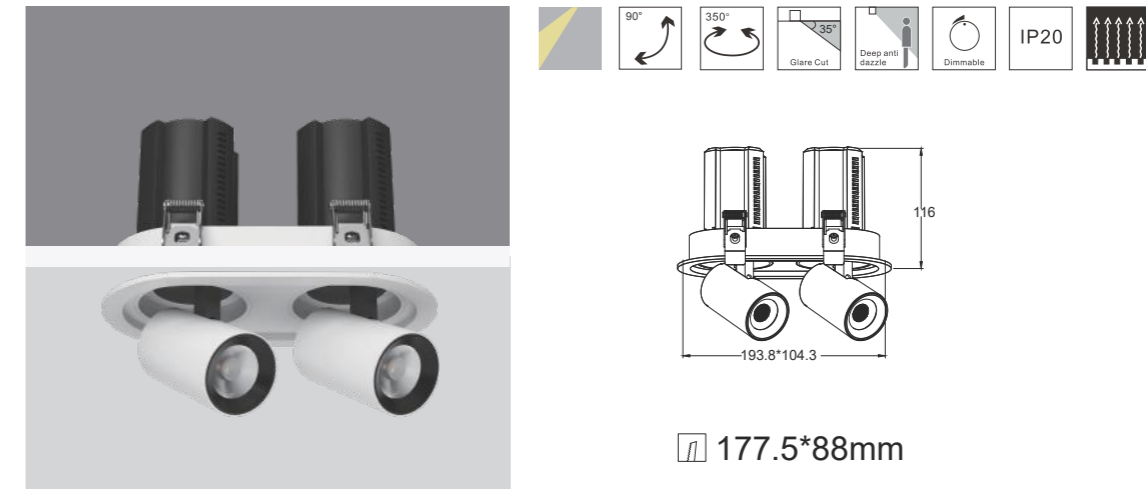
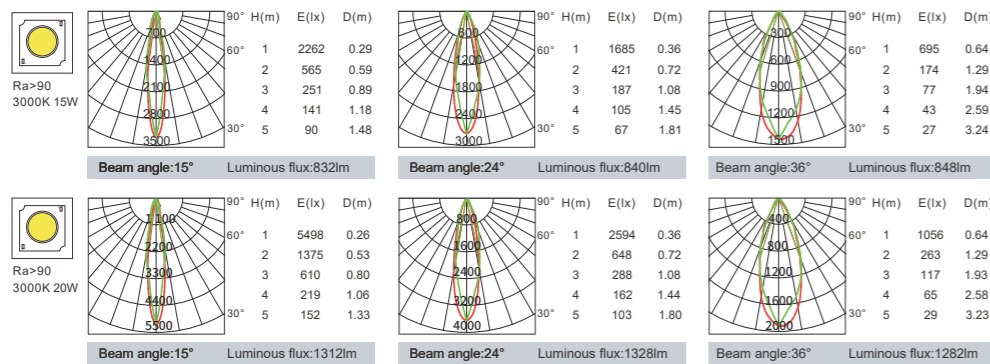

Model	Power	LED voltage	LED Current	CRI	CCT	Beam Angle	LED Output	System output	Dimming Type
KS-DL10L-C2-320	20W	36V	2*250mA	90	2700K	15°	864*2lm	1512lm	ON-OFF
						24°	864*2lm	1568lm	TRIAC
						36°	864*2lm	1528lm	1-10V
						50°	864*2lm	1534lm	DALI
	20W	36V	2*250mA	90	3000K	15°	916*2lm	1604lm	ON-OFF
						24°	916*2lm	1668lm	TRIAC
						36°	916*2lm	1622lm	1-10V
						50°	916*2lm	1628lm	DALI
	20W	36V	2*250mA	90	4000K	15°	968*2lm	1752lm	ON-OFF
						24°	968*2lm	1718lm	TRIAC
						36°	968*2lm	1714lm	1-10V
						50°	968*2lm	1720lm	DALI
KS-DL10L-C2-324	24W	36V	2*300mA	90	2700K	15°	1037*2lm	1756lm	ON-OFF
						24°	1037*2lm	1934lm	TRIAC
						36°	1037*2lm	1894lm	1-10V
						50°	1037*2lm	1808lm	DALI
	24W	36V	2*300mA	90	3000K	15°	1100*2lm	1864lm	ON-OFF
						24°	1100*2lm	2052lm	TRIAC
						36°	1100*2lm	2010lm	1-10V
						50°	1100*2lm	1918lm	DALI
	24W	36V	2*300mA	90	4000K	15°	1162*2lm	1968lm	ON-OFF
						24°	1162*2lm	2166lm	TRIAC
						36°	1162*2lm	2122lm	1-10V
						50°	1162*2lm	2026lm	DALI

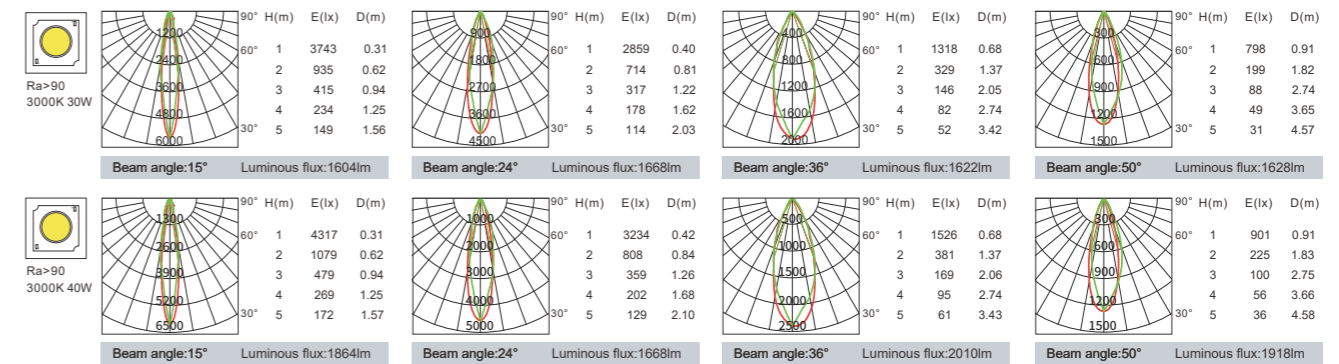

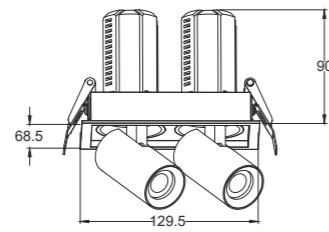
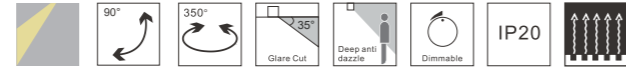
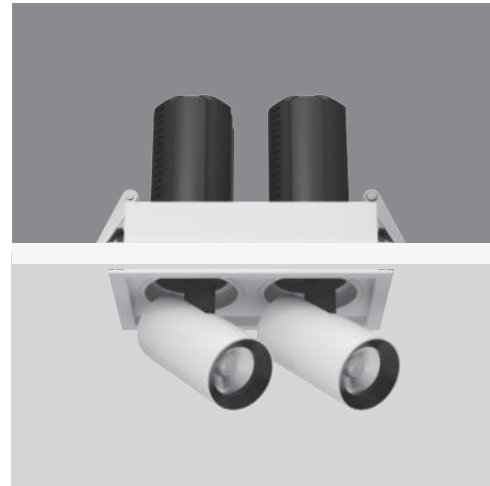

121.5\*60mm

Model	Power	LED voltage	LED Current	CRI	CCT	Beam Angle	LED Output	System output	Dimming Type
KS-DL10L-S2-210	10W	36V	2*120mA	90	2700K	15°	415*2lm	784lm	ON-OFF
						24°	415*2lm	792lm	TRIAC
						36°	415*2lm	798lm	1-10V
						50°	415*2lm	804lm	DALI
	10W	36V	2*120mA	90	3000K	15°	440*2lm	832lm	ON-OFF
						24°	440*2lm	840lm	TRIAC
						36°	440*2lm	848lm	1-10V
						50°	440*2lm	854lm	DALI
	10W	36V	2*120mA	90	4000K	15°	465*2lm	879lm	ON-OFF
						24°	465*2lm	886lm	TRIAC
						36°	465*2lm	896lm	1-10V
						50°	465*2lm	902lm	DALI
KS-DL10L-S2-216	16W	36V	2*200mA	90	2700K	15°	691*2lm	1236lm	ON-OFF
						24°	691*2lm	1250lm	TRIAC
						36°	691*2lm	1208lm	1-10V
						50°	691*2lm	1322lm	DALI
	16W	36V	2*200mA	90	3000K	15°	733*2lm	1312lm	ON-OFF
						24°	733*2lm	1328lm	TRIAC
						36°	733*2lm	1282lm	1-10V
						50°	733*2lm	1404lm	DALI
	16W	36V	2*200mA	90	4000K	15°	775*2lm	1386lm	ON-OFF
						24°	775*2lm	1404lm	TRIAC
						36°	775*2lm	1354lm	1-10V
						50°	775*2lm	1484lm	DALI

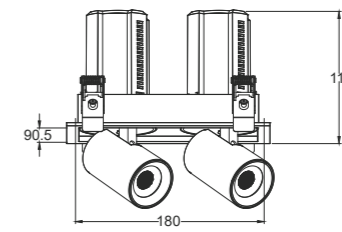
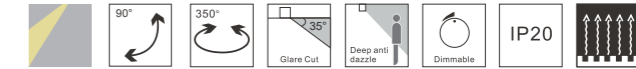
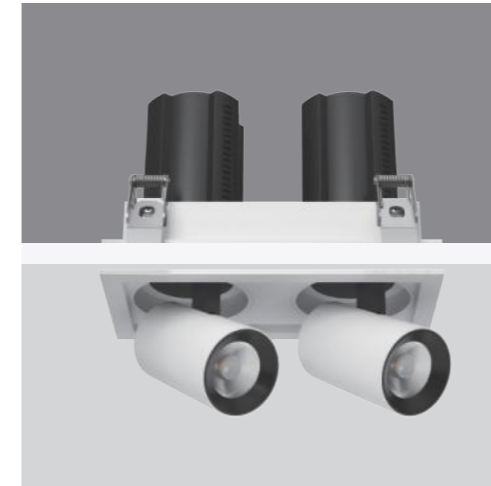

177.5\*88mm

Model	Power	LED voltage	LED Current	CRI	CCT	Beam Angle	LED Output	System output	Dimming Type
KS-DL10L-S2-320	20W	36V	2*250mA	90	2700K	15°	864*2lm	1512lm	ON-OFF
						24°	864*2lm	1568lm	TRIAC
						36°	864*2lm	1528lm	1-10V
						50°	864*2lm	1534lm	DALI
	20W	36V	2*250mA	90	3000K	15°	916*2lm	1604lm	ON-OFF
						24°	916*2lm	1668lm	TRIAC
						36°	916*2lm	1622lm	1-10V
						50°	916*2lm	1628lm	DALI
	20W	36V	2*250mA	90	4000K	15°	968*2lm	1752lm	ON-OFF
						24°	968*2lm	1718lm	TRIAC
						36°	968*2lm	1714lm	1-10V
						50°	968*2lm	1720lm	DALI
KS-DL10L-S2-324	24W	36V	2*300mA	90	2700K	15°	1037*2lm	1756lm	ON-OFF
						24°	1037*2lm	1934lm	TRIAC
						36°	1037*2lm	1894lm	1-10V
						50°	1037*2lm	1808lm	DALI
	24W	36V	2*300mA	90	3000K	15°	1100*2lm	1864lm	ON-OFF
						24°	1100*2lm	2052lm	TRIAC
						36°	1100*2lm	2010lm	1-10V
						50°	1100*2lm	1918lm	DALI
	24W	36V	2*300mA	90	4000K	15°	1162*2lm	1968lm	ON-OFF
						24°	1162*2lm	2166lm	TRIAC
						36°	1162*2lm	2122lm	1-10V
						50°	1162*2lm	2026lm	DALI

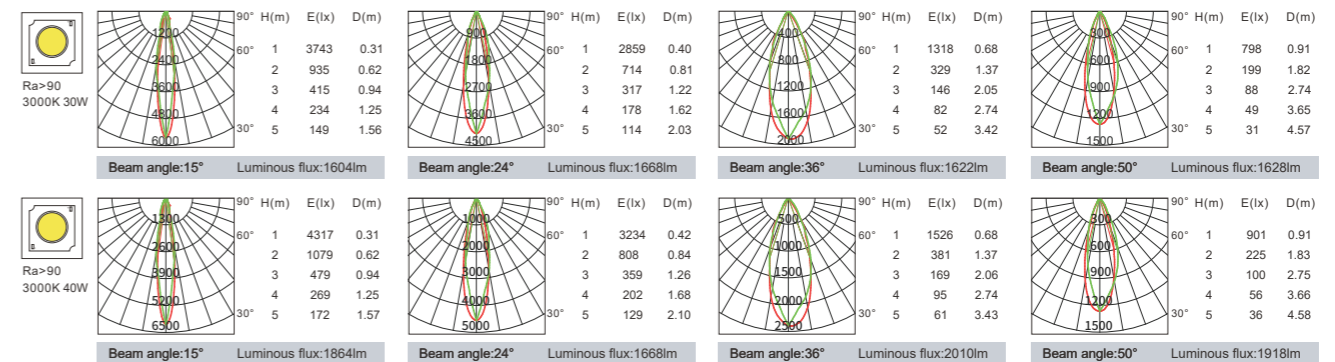
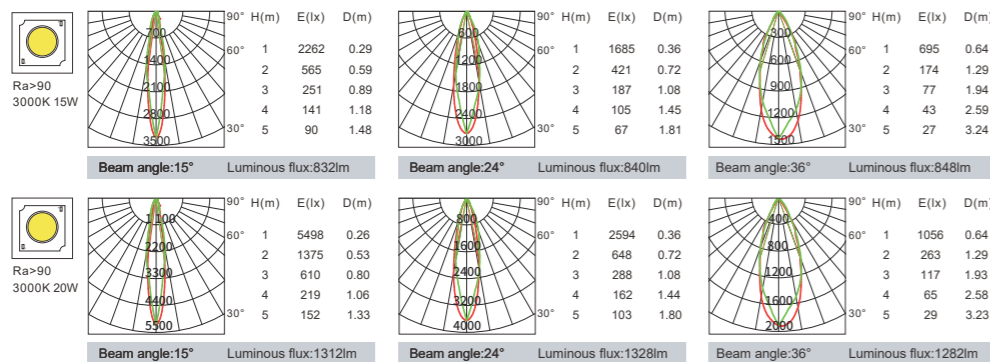

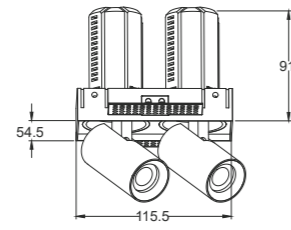
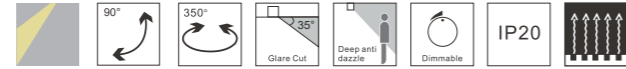
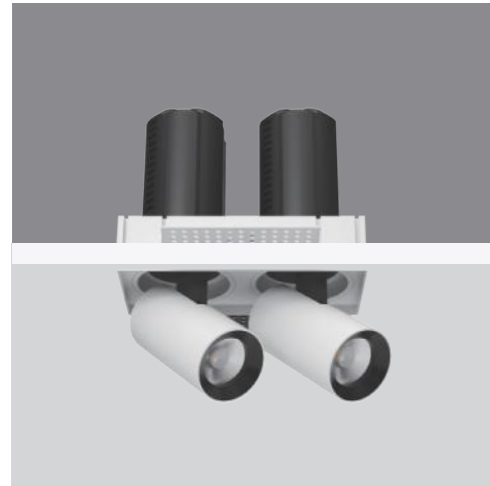

123\*62.5mm

Model	Power	LED voltage	LED Current	CRI	CCT	Beam Angle	LED Output	System output	Dimming Type
KS-DL10L-SE2-210	10W	36V	2*120mA	90	2700K	15°	415*2lm	784lm	ON-OFF
						24°	415*2lm	792lm	TRIAC
						36°	415*2lm	798lm	1-10V
						50°	415*2lm	804lm	DALI
	10W	36V	2*120mA	90	3000K	15°	440*2lm	832lm	ON-OFF
						24°	440*2lm	840lm	TRIAC
						36°	440*2lm	848lm	1-10V
						50°	440*2lm	854lm	DALI
	10W	36V	2*120mA	90	4000K	15°	465*2lm	879lm	ON-OFF
						24°	465*2lm	886lm	TRIAC
						36°	465*2lm	896lm	1-10V
						50°	465*2lm	902lm	DALI
KS-DL10L-SE2-216	16W	36V	2*200mA	90	2700K	15°	691*2lm	1236lm	ON-OFF
						24°	691*2lm	1250lm	TRIAC
						36°	691*2lm	1208lm	1-10V
						50°	691*2lm	1322lm	DALI
	16W	36V	2*200mA	90	3000K	15°	733*2lm	1312lm	ON-OFF
						24°	733*2lm	1328lm	TRIAC
						36°	733*2lm	1282lm	1-10V
						50°	733*2lm	1404lm	DALI
	16W	36V	2*200mA	90	4000K	15°	775*2lm	1386lm	ON-OFF
						24°	775*2lm	1404lm	TRIAC
						36°	775*2lm	1354lm	1-10V
						50°	775*2lm	1484lm	DALI

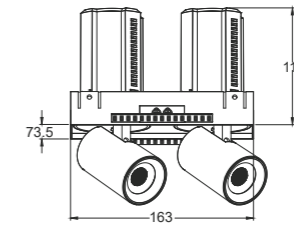
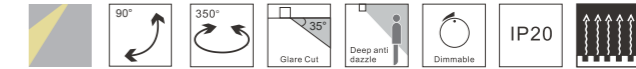
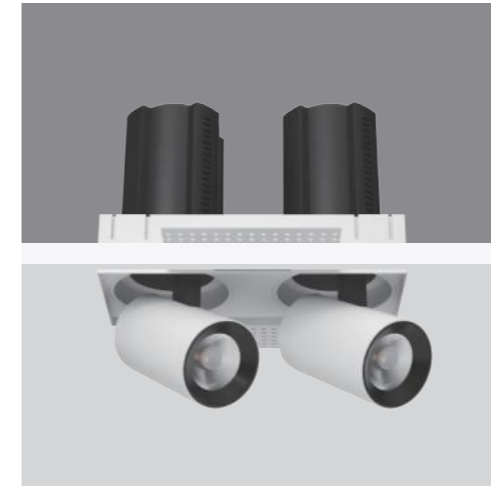
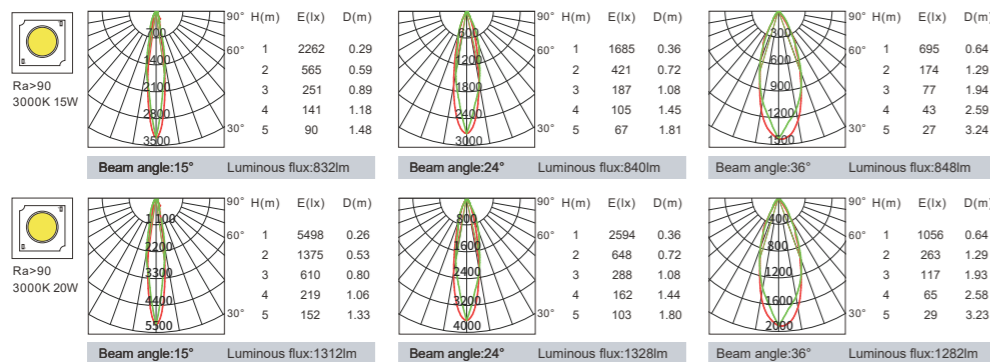

166.5\*79.5mm

Model	Power	LED voltage	LED Current	CRI	CCT	Beam Angle	LED Output	System output	Dimming Type
KS-DL10L-SE2-320	20W	36V	2*250mA	90	2700K	15°	864*2lm	1512lm	ON-OFF
						24°	864*2lm	1568lm	TRIAC
						36°	864*2lm	1528lm	1-10V
						50°	864*2lm	1534lm	DALI
	20W	36V	2*250mA	90	3000K	15°	916*2lm	1604lm	ON-OFF
						24°	916*2lm	1668lm	TRIAC
						36°	916*2lm	1622lm	1-10V
						50°	916*2lm	1628lm	DALI
	20W	36V	2*250mA	90	4000K	15°	968*2lm	1752lm	ON-OFF
						24°	968*2lm	1718lm	TRIAC
						36°	968*2lm	1714lm	1-10V
						50°	968*2lm	1720lm	DALI
KS-DL10L-SE2-324	24W	36V	2*300mA	90	2700K	15°	1037*2lm	1756lm	ON-OFF
						24°	1037*2lm	1934lm	TRIAC
						36°	1037*2lm	1894lm	1-10V
						50°	1037*2lm	1808lm	DALI
	24W	36V	2*300mA	90	3000K	15°	1100*2lm	1864lm	ON-OFF
						24°	1100*2lm	2052lm	TRIAC
						36°	1100*2lm	2010lm	1-10V
						50°	1100*2lm	1918lm	DALI
	24W	36V	2*300mA	90	4000K	15°	1162*2lm	1968lm	ON-OFF
						24°	1162*2lm	2166lm	TRIAC
						36°	1162*2lm	2122lm	1-10V
						50°	1162*2lm	2026lm	DALI

